

# La Redoute

♦ INTERIEURS ♦

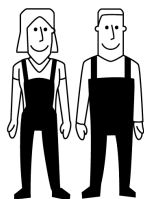

MOYEN - MEDIUM  
MITTEL - MEDIO



2

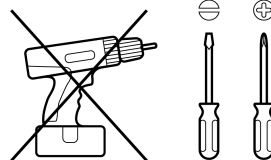

FR / Si vous avez des questions sur votre produit, email: [sitegsm@redoute.fr](mailto:sitegsm@redoute.fr) ou appeler au: 0 969 323 515.

UK / If you need information about your product, email [helpline@redoute.co.uk](mailto:helpline@redoute.co.uk) or call: 033 0303 0199.

CH / Wenn Sie Fragen zu Ihrem Produkt, email: [info@redoute.ch](mailto:info@redoute.ch) oder anrufen: FR/IT: 0848 848 505, DE: 0848 848 505.

BE / Si vous avez des questions sur votre produit, email: [serviceclient@redoute.be](mailto:serviceclient@redoute.be) ou appeler: 056 85 15 15 - Als u vragen over uw product, email: [klantendienst@redoute.be](mailto:klantendienst@redoute.be) of bel: 056 85 15 00.

ES / Si tiene alguna pregunta acerca de su producto, email: [contacto@laredoute.es](mailto:contacto@laredoute.es) o llamar: 902 33 00 33.

PT / Se você tiver dúvidas sobre o seu produto, email: [contacto@redoute.pt](mailto:contacto@redoute.pt) ou chamar: 707201010.

SE / Om du har frågor om din produkt, email: [service@laredoute.se](mailto:service@laredoute.se) eller ring: 033 - 48 20 00.

NW / Hvis du trenger informasjon om produktet, email: [service@laredoute.no](mailto:service@laredoute.no) eller telefon: 66-89-15-00.

IT / Se hai delle domande sul tuo articolo, ecco la mail via nuestro website.

PL / Jeżeli mają Państwo pytania dotyczące produktu, prosimy pisać na numer telefonu: 32 225 28 28.

RU / Если Вам необходима дополнительная информация о товаре, свяжитесь с нами по телефонам 8 800 555 75 35 / 8 (495) 795 30 30, email: [info@laredoute.ru](mailto:info@laredoute.ru).

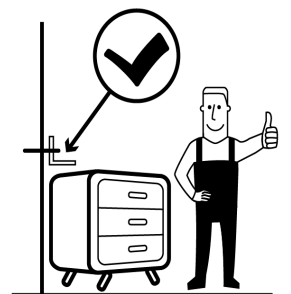
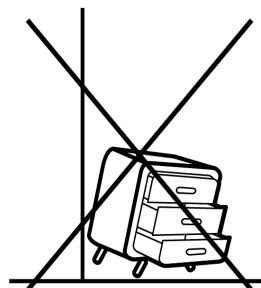
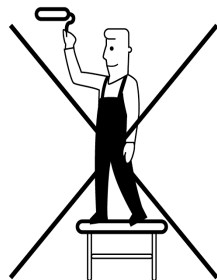
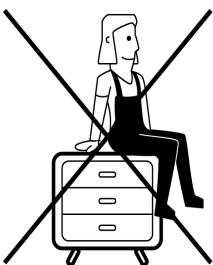
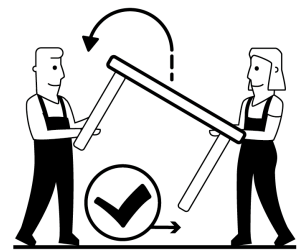
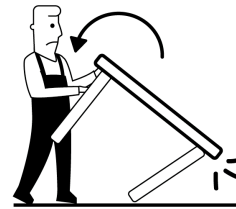
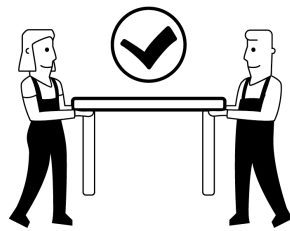
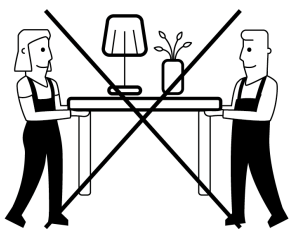
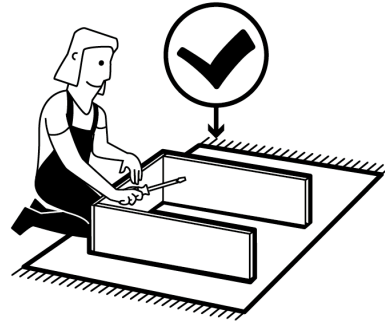
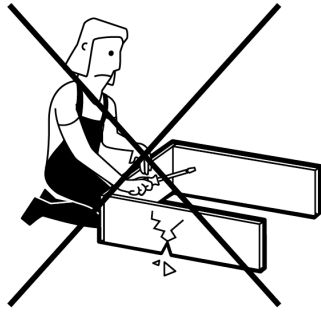

FR - Nous vous remercions pour votre achat. Nous espérons que ce produit répondra pleinement à vos attentes et vous satisfera au quotidien.

#### AVERTISSEMENT DE SECURITE

Information importante si votre meuble est muni d'une attache murale. En cas de chute du meuble, il y a un risque de blessures graves. Pour éviter que le meuble ne bascule, il faut le fixer au mur de façon permanente. Les fixations murales ne sont pas incluses car leur choix dépend du matériau du mur. Nous vous conseillons alors de vous adresser à un revendeur spécialisé pour obtenir des conseils sur les fixations adaptées à votre type de mur.

#### CONSEILS AVANT MONTAGE

Contrôlez le contenu de votre colis avant de procéder au montage. Assemblez ensuite le meuble en suivant l'ordre défini par la notice et si possible dans la pièce de destination.

---

---

DE - Vielen Dank für Ihren Einkauf. Wir hoffen, dass dieses Produkt wird voll und ganz erfüllen Ihre Anforderungen und erfüllen Sie im Alltag.

#### ACHTUNG

Wichtige Informationen, wenn Ihr Schrank hat einen Maueranker. Bei Möbel umkippen, besteht die Gefahr von schweren Verletzungen. Damit das Gehäuse vor dem Umkippen zu verhindern, müssen wir die permanente Wand zu befestigen. Wandhalterungen sind nicht enthalten, da ihre Wahl hängt von der Wandmaterial. Wir empfehlen Ihnen, die Sie an einen Fachhändler um Rat, Anhänge für Ihre Wand Typ angepasst beziehen.

#### VOR DER MONTAGE

Überprüfen Sie den Inhalt des Pakets vor der Installation.

Montieren Sie die Möbel in der durch das Protokoll festgelegten Reihenfolge.

---

---

PT - Agradecemos a sua compra. Esperamos que este produto satisfaça plenamente as suas necessidades e seja um valioso contributo para o seu quotidiano.

#### AVISO DE SEGURANÇA

Informação importante caso o seu artigo esteja preparado para fixar à parede. A eventual queda de móveis, representa o risco de ferimentos graves. Para evitar que o móvel tombe, deve ser convenientemente fixado a uma parede. Os suportes de parede não estão incluídos porque a sua escolha depende do material da parede. Aconselhamos que consulte um vendedor especializado para se aconselhar relativamente aos suportes adequados para o seu tipo de parede.

#### ANTES DA MONTAGEM

Verifique o conteúdo da embalagem antes da instalação.

Montar os móveis na ordem indicada pelas instruções.

---

---

SE - Tack för ditt köp. Vi hoppas att denna produkt kommer att fullt ut uppfyller dina krav och tillfredsställa dig i vardagen.

#### SÄKERHETSVARNING

Viktig information om ditt skåp har en vägg slips. Vid möbler falla, finns det en risk för allvarlig skada. För att förhindra att skåpet tippar, måste vi fixa permanent väggen. Väggekonsoler ingår inte eftersom deras val beror på väggmaterialet. Vi råder dig att hänvisa dig till en auktoriserad återförsäljare för råd om tillbehör anpassade för din vägg typ.

#### FORE MONTERING

Kontrollera innehållet i förpackningen före installationen.

Montera sedan möblerna i den ordning som definieras av posten.

---

---

IT - Ti ringraziamo per il tuo acquisto. Speriamo che questo articolo ti darà piena soddisfazione.

#### AVVISO DI SICUREZZA

Informazione importante se il tuo mobile è dotato di un supporto a parete. Nel caso della caduta di un mobile vi è il rischio di lesioni gravi. Per evitare che il mobile cada, è necessario fissarlo al muro in modo permanente. L'occorrenza per fissarlo al muro non è incluso perché questo dipende dal materiale della parete. Ti consigliamo di contattare un rivenditore per avere un consiglio sugli elementi di fissaggio su misura per il tipo di parete.

#### CONSIGLI prima del montaggio

Verifica il contenuto della confezione prima di procedere all'installazione. Poi assembla i mobili nell'ordine definito nelle istruzioni e, se possibile nella stanza di destinazione.

---

---

RU - Благодарим Вас за покупку. Мы надеемся, что данный товар полностью соответствует Вашим ожиданиям и долго прослужит в использовании.

#### ОСТОРОЖНО

Внимательно прочитайте следующую информацию в случае, если ваш предмет интерьера предполагает крепление к стене. В случае падения предмета, имеется риск получения травм. Во избежание раскачивания предмета, следует прочно закрепить его на стене. Настенные крепления не входят в комплект по причине того, что их выбор зависит от материала, из которого изготовлена стена. Мы советуем Вам обратиться к специалисту, который поможет Вам подобрать соответствующее крепление для вашего типа стены.

#### СОВЕТЫ ПО СБОРКЕ

Прежде чем приступить к сборке, убедитесь, что в коробке находятся все заявленные детали предмета мебели. Крепите детали в соответствии с порядком, указанным в прилагаемой листовке, и, при возможности, в том помещении, где предполагается его установка.

---

---

UK - We thank you for your purchase. We hope this product will satisfy you in everyday life.

#### IMPORTANT SECURITY WARNING

Important information if your furniture is equipped with an anti-tipping device. In case of furniture tip-over, there is a risk of serious crushing injuries. To prevent the furniture from tipping-over, it must be permanently fixed to the wall. Wall fixing devices are not included since their choice depends on the wall material. We advise you to refer you to a specialized dealer for advice on suitable fixing systems for your wall type.

#### BEFORE ASSEMBLY

Check the contents of your package prior to assemble your furniture.

Assemble then the furniture in the order defined by the assembly instruction

---

---

NL - Dank u voor uw aankoop. We hopen dat dit artikel volledig aan uw wensen zal voldoen.

#### VEILIGHEIDSWAARSCHUWING

Belangrijke informatie indien uw meubel aan de muur bevestigd moet worden. Bij het vallen van meubels kunnen er ernstige letsels ontstaan. Om te vermijden dat het meubel kantelt, moet het goed bevestigd worden aan de muur of wand. Muurbevestigingen zijn niet inbegrepen omdat de keuze daarvan afhangt van het soort wand. Wij raden u aan om een specialist te raadplegen ivm het type bevestigingen voor uw type wand.

#### VOÓR DE MONTAGE

Controleer de inhoud van het pakket voor de installatie.

Monteer vervolgens het meubel door de handleiding te volgen.

---

---

ES - Muchas gracias por adquirir este producto. Esperamos que estés satisfecho/a con tu compra y que este producto responda plenamente a tus necesidades.

#### AVISO DE SEGURIDAD

Información importante si tu mueble tiene sujeción a la pared. En el caso de que el mueble caiga, existe el riesgo de heridas graves. Para evitar que el mueble se mueva, hay que fijarlo de forma permanente a la pared. Las piezas de fijación a la pared no están incluidas porque su elección depende del tipo de material de la pared. Te aconsejamos que te dirijas a un vendedor especializado que te aconseje sobre las piezas más adecuadas para tu tipo de pared.

#### ANTES DEL MONTAJE

Comprueba el contenido del paquete antes de empezar el montaje.

Monta el mueble de inmediato siguiendo el orden definido en las instrucciones.

---

---

NE - Takk for kjøpet. Vi håper dette produktet vil fullt ut oppfyller dine krav og tilfredsstille deg i hverdagen.

#### SIKKERHET

Viktig informasjon om kabinettet har en vegg tie. Ved møbler fall, er det en risiko for alvorlig skade. For å hindre at kabinettet tipper, må vi fikse permanent vegg. Veggbraket-ter er ikke inkludert fordi deres valg avhenger av veggmaterialet. Vi anbefaler deg å henvise deg til en spesialist forhandler for råd om vedlegg tilpasset din veggtype.

#### FØR MONTERING

Sjekk innholdet i pakken før installasjonen.

Monter deretter møblene i den rekkefølgen definert av posten.

---

---

PL - Dziękujemy Państwu za zakup naszego produktu. Mamy nadzieję, że produkt ten spełni wszystkie Państwa oczekiwania i będzie Państwu służyć na co dzień.

#### WSKAZÓWKI BEZPIECZEŃSTWA

Ważna informacja: jeśli Państwa mebel posiada zaczep ścienny. W przypadku przewrócenia się mebla istnieje ryzyko ciężkich obrażeń. Aby uniknąć przesuwania się mebla, należy go przymocować na stałe do ściany. Mocowania ścienne nie znajdują się w zestawie, ponieważ ich wybór zależy od rodzaju ściany. Należy zwrócić się do specjalisty handlowego w celu otrzymania porady dotyczącej odpowiedniego mocowania do Państwa rodzaju ścian.

#### ZALECENIA PRZED MONTAŻEM

Przed przystąpieniem do montażu, należy sprawdzić zawartość paczki.

Mebel należy montować zgodnie z kolejnością opisaną w instrukcji i w miarę możliwości w pomieszczeniu, w którym będzie ustawiony.

---

---

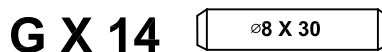
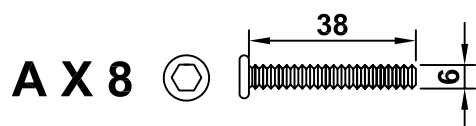
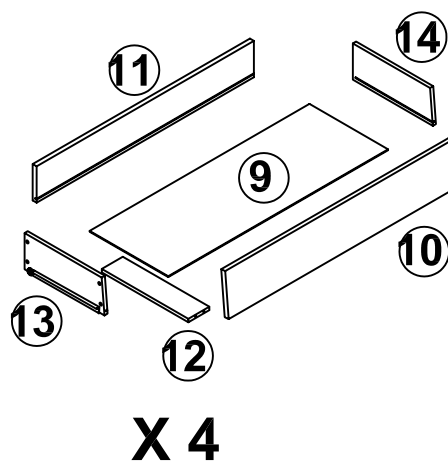
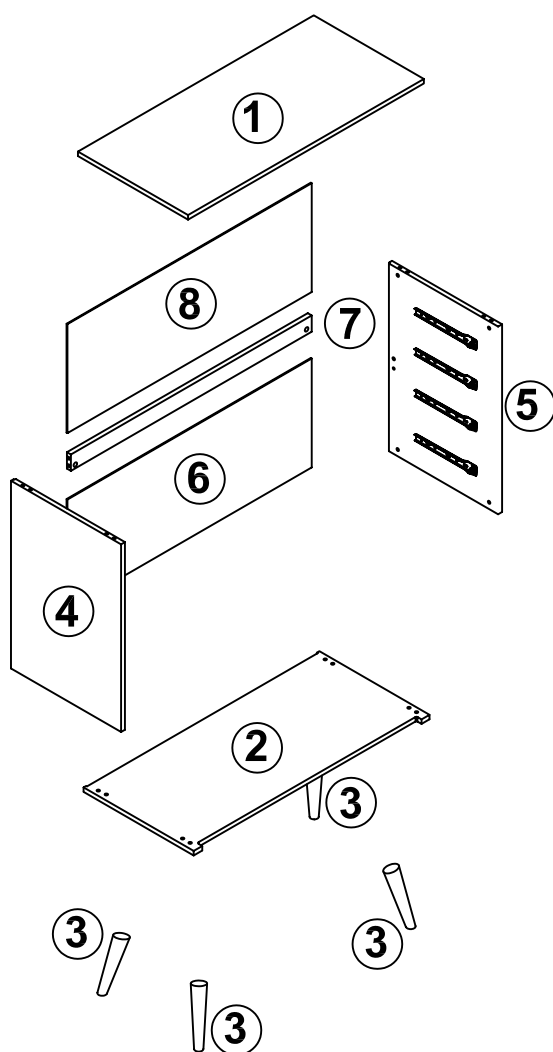

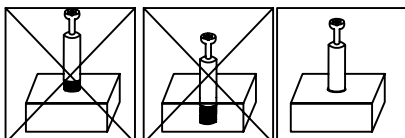
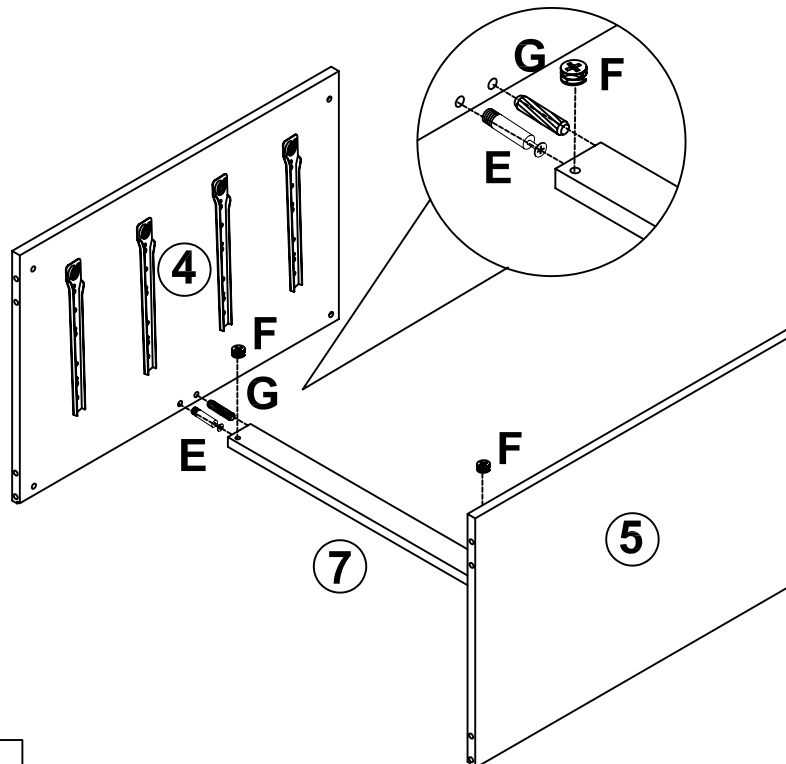
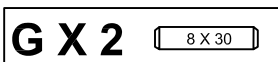
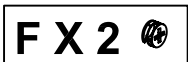
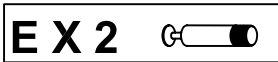
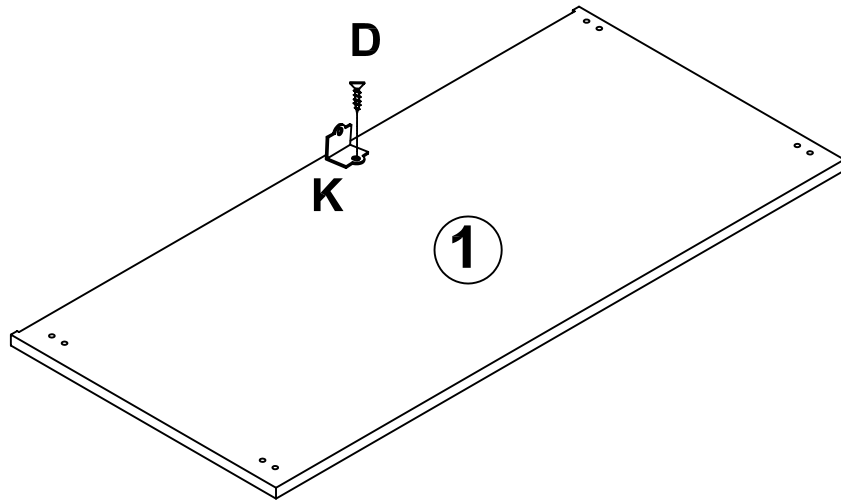
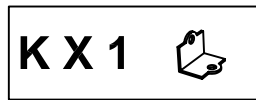
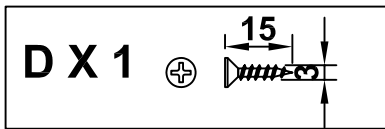

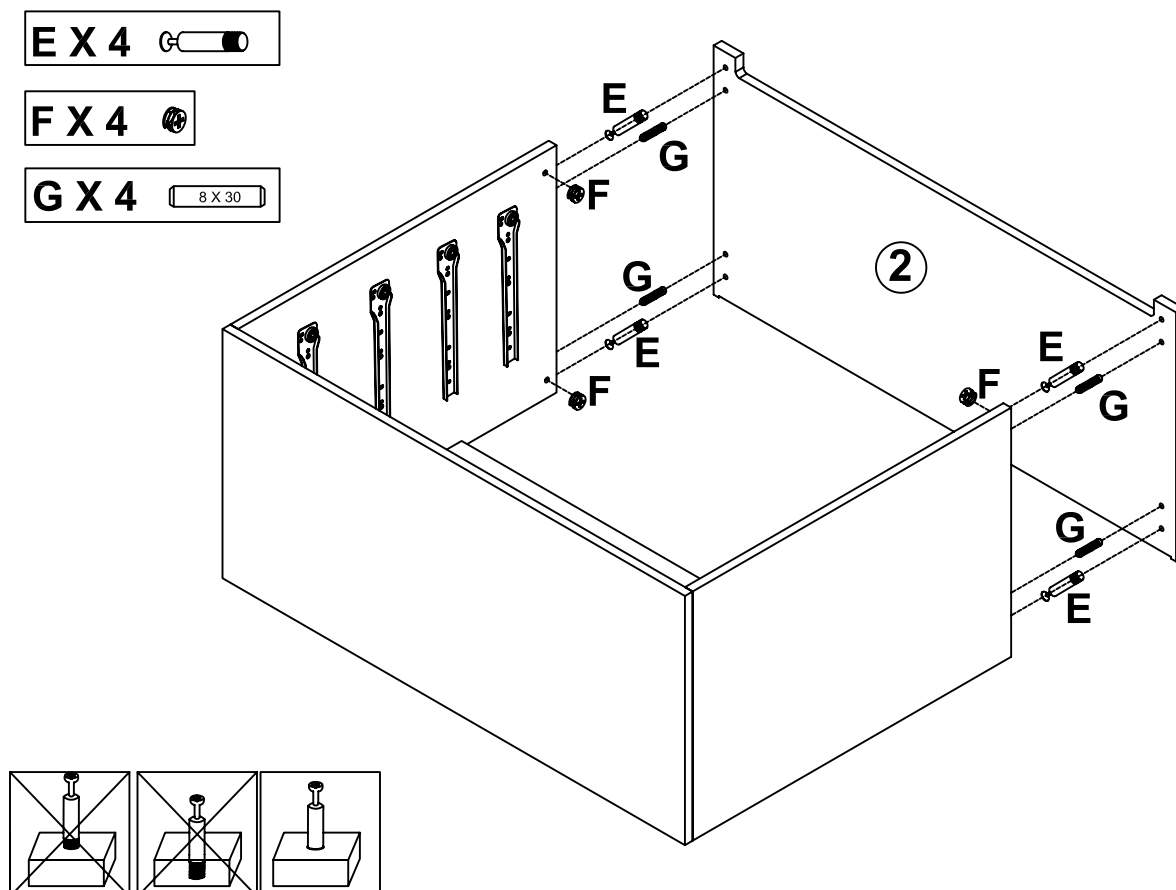
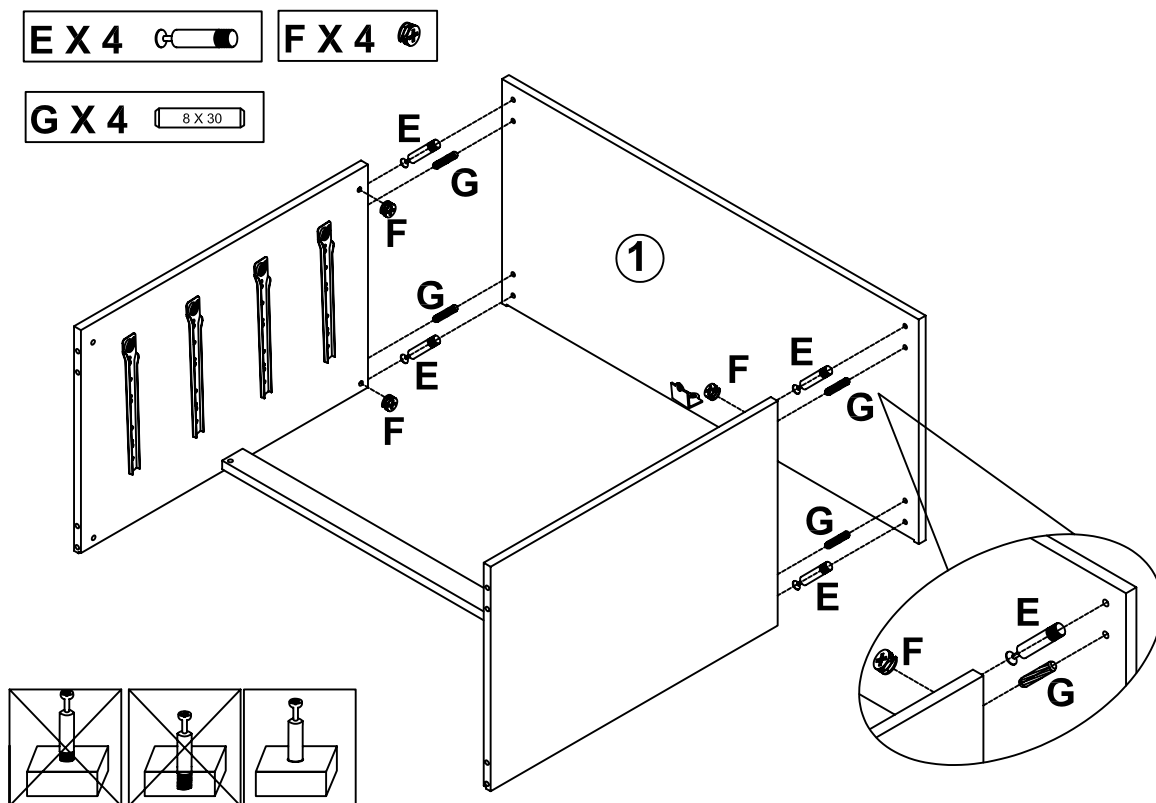

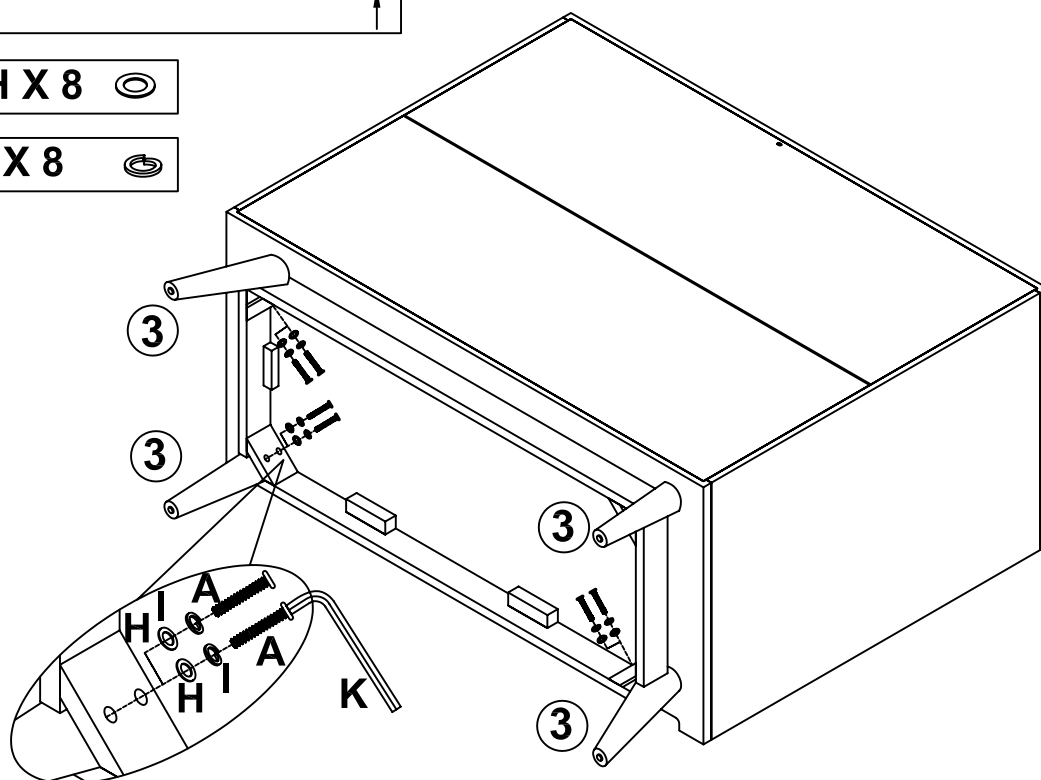
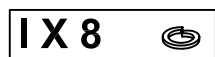
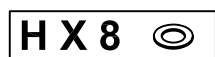
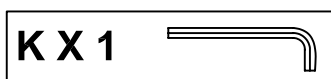
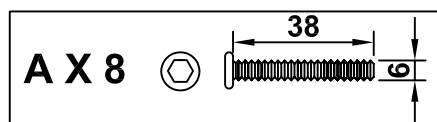
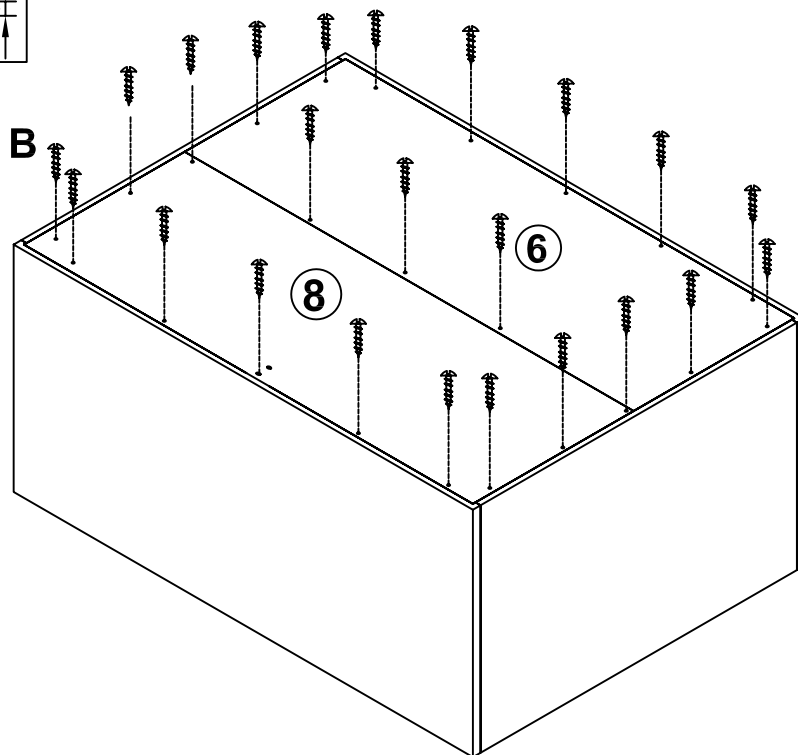
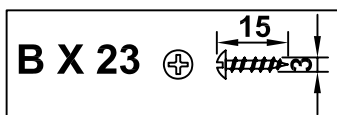

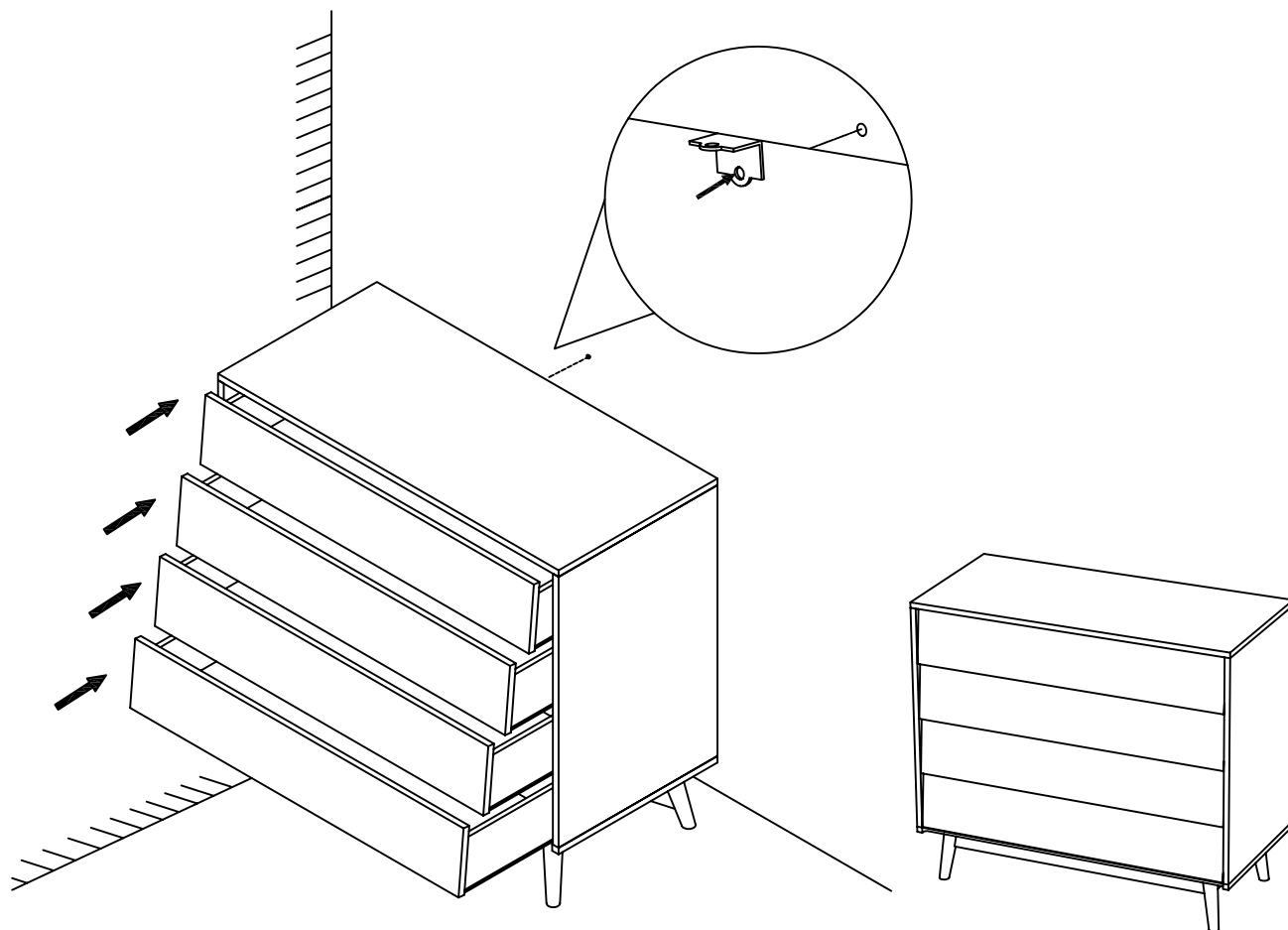
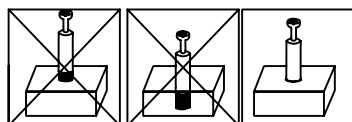
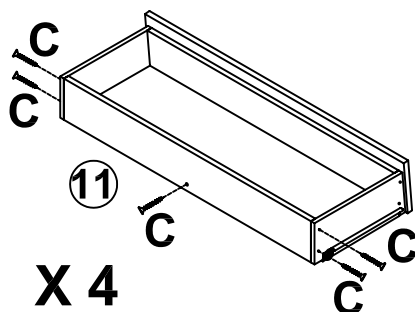
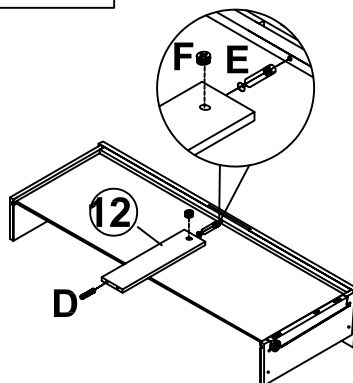
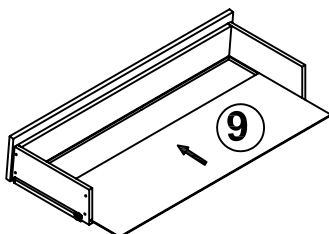
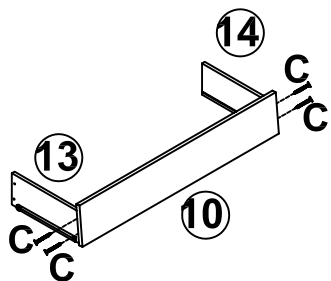
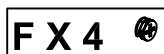
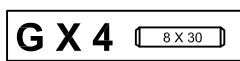
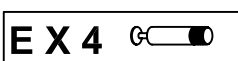
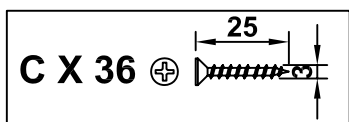





Il existe une grande diversité de types de murs ou cloisons, c'est la raison pour laquelle nous ne pouvons vous fournir le type exact de fixation. Il est nécessaire d'identifier le type de paroi à laquelle vous allez fixer ce produit afin de vous procurer les fixations appropriées. Voici quelques exemples de fixations conseillées pour :



**LES MURS PLEINS**

**CHEVILLE NYLON  
"FISCHER"**

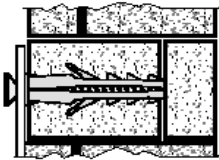
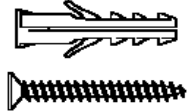

**CHEVILLE D'ANCRAGE  
MÉTAL**

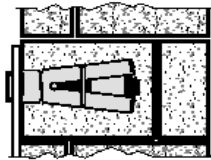
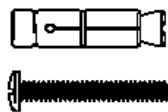

**CHEVILLE D'ANCRAGE  
A AILETTES EN NYLON**

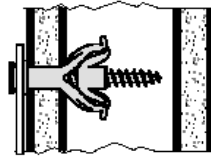
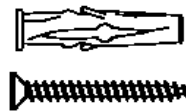

**LES CLOISONS CREUSES**

**CHEVILLE MÉTALLIQUE  
A EXPENSION**

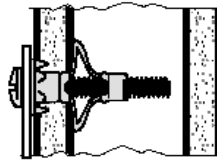
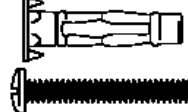

**CHEVILLE "MOLLY"**

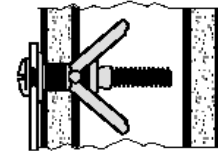
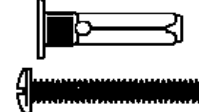

Utiliser une taille de forêt adaptée à la quincaillerie utilisée et au type de mur.



Due to the wide diversity of wall or partition types, we cannot provide you with suitable attachment fixtures . To determine which attachment fixtures to use, you will need to identify the type of wall to which you will be fixing this product. Here are some examples of attachment fixtures recommended for:

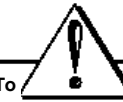

**BLIND WALLS**

**"FISCHER"  
Nylon plug**

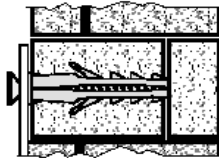
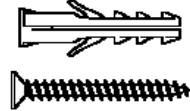

**Metal  
Wall plug**

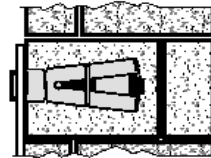
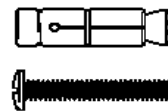

**Nylon winged  
Wall plug**

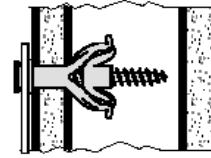
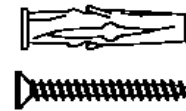

**STUDDED WALLS**

**Metal expansion  
plug**

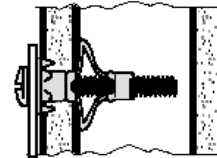
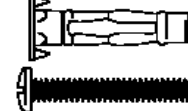

**"MOLLY" plug**

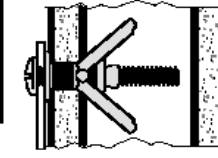
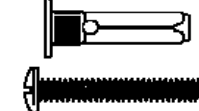

Use a drill bit that is compatible in size with the hardware used and the type of wall.



Esiste una gran varietà di tipi di muri o paratie e noi siamo in grado di fornirvi il tipo esatto di fissaggio per ognuno di essi. E' necessario identificare il tipo di parete alla quale intendete fissare questo prodotto in modo da fornirvi i fissaggi più idonei. Ecco qualche esempio di fissaggi consigliati per :



**I MURI PIENI**

**TASSELLO NYLON  
"FISCHER"**

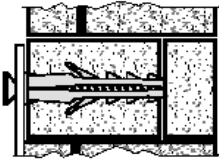
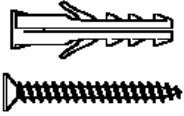

**TASSELLO DI  
ANCORAGGIO IN  
METALLO**

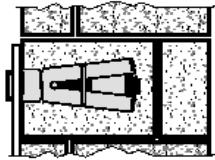
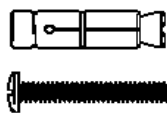

**TASSELLO DI  
ANCORAGGIO AD  
ALETTE IN NYLON**

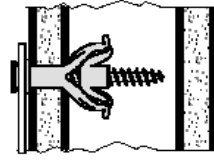
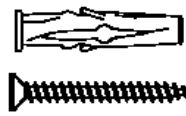

**PARATIE CAVE  
TASSELLO METALLICO  
AD ESPANSIONE**

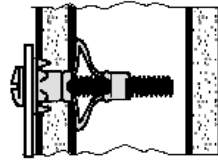
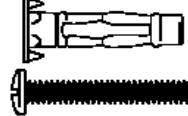

**TASSELLO  
"MOLLY"**

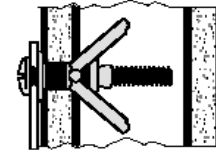
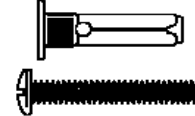

Utilizzare una punta di trapano adatta agli utensili utilizzati e al tipo di muro.



Es gibt eine Vielzahl verschiedener Arten von Mauern oder Zwischenwänden, und aus diesem Grunde können wir Ihnen den genau entsprechenden Befestigungstyp nicht bereitstellen. Zunächst ist es erforderlich, die exakte Bauart der Wand zu ermitteln, an der Sie dieses Produkt anbringen werden, um die für diese Wand geeigneten Befestigungsmittel im Fachhandel erwerben zu können. Nachfolgend einige Beispiele empfohlener Befestigungen für:



**VOLLWÄNDE**

**NYLONDÜBEL  
„FISCHER“**

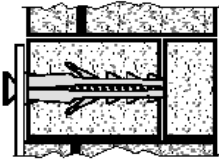
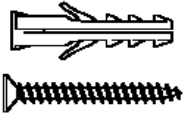

**ANKERDÜBEL  
AUS METALL**

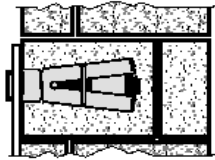
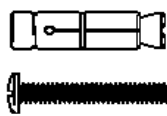

**ANKERDÜBEL MIT  
NYLONFLÜGELN**

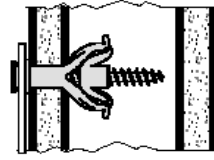
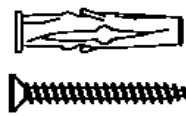

**HOHLWÄNDE  
SPREIZDÜBEL FÜR  
VERANKERUNG AUS METALL**

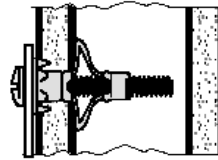
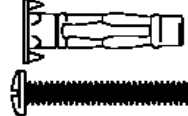

**MOLLY-DÜBEL**

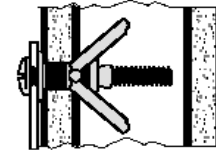
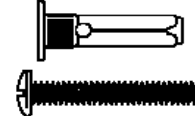

Bitte verwenden Sie eine für die Eisenwaren und den Wandtyp geeignete Bohrergröße.