

Ref: GNK186



20 min

E27 - MAX 40W
(non incluses)



Utilisation à l'intérieur uniquement
For indoor use only

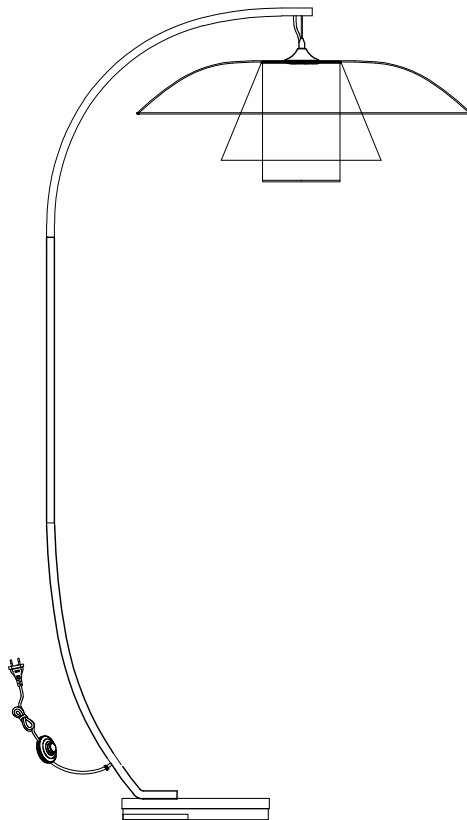

MOYEN - MEDIUM
MITTEL - MEDIO

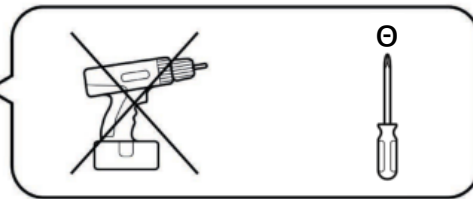
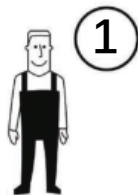

FR / Pour toute demande de SAV, contactez-nous via l'espace dédié « demande de SAV » accessible dans votre suivi de commandes sur notre site www.laredoute.fr, ou nous contacter au 0 969 323 515.

UK / If you need information about your product, email helpline@redoute.co.uk or call: 033 0303 0199.

CH / Wenn Sie Fragen zu Ihrem Produkt, email: info@redoute.ch oder anrufen: FR/IT: 0848 848 505, DE: 0848 848 505.

BE / Si vous avez des questions sur votre produit, email: serviceclient@redoute.be ou appeler: 056 85 15 15 - Als u vragen over uw product, email: klantendienst@redoute.be of bel: 056 85 15 00.

ES / Si tiene alguna pregunta acerca de su producto, email: contacto@laredoute.es o llamar: 902 33 00 33.

PT / Se você tiver dúvidas sobre o seu produto, email: contacto@redoute.pt ou chamar: 707201010.

SE / Om du har frågor om din produkt, email: service@laredoute.se eller ring: 033 - 48 20 00.

NW / Hvis du trenger informasjon om produktet, email: service@laredoute.no eller telefon: 66-89-15-00.

IT / Se hai delle domande sul tuo articolo, ecco la mail via nuestro website.

PL / Jeśli mają Państwo pytania dotyczące produktu, prosimy pisać na numer telefonu: 32 225 28 28.

RU / Если Вам необходима дополнительная информация о товаре, свяжитесь с нами по телефонам 8 800 555 75 35 / 8 (495) 795 30 30, email: info@laredoute.ru.





Avertissement!/ Warning!

F A monter par un adulte. Contrôler le contenu de votre colis avant de procéder au montage. Attention: tenir les vis et petits éléments et sachets hors de portée des enfants. Ne jetez pas l'emballage, il vous sera très utile pour protéger les éléments des coups et rayures pendant le montage. Assemblez ensuite l'article en suivant l'ordre défini par la numérotation. Pour une utilisation à l'intérieur uniquement. Respecter l'ampoule recommandée. Il est impératif de couper le circuit électrique avant toute opération. Toujours débrancher la lampe et attendre 10 minutes avant toute opération. Fabriqué en Chine





GB To be assembled by an adult. Check the content of your parcel before assembling. Caution : Keep all screws, small parts and plastic bag out of the reach of small children. Do not throw away the packing which could be very useful to protect the panels from knocks and scratches when assembling. Assemble the article following the order of the numbers indicated. For indoor use only. To respect the bulb recommended. Cut the electric circuit before all operations. Always switch off the electricity supply and allow to cool for 10 minutes before modifications. made in China.

Ref: GNK186

EAN: 3614855100944





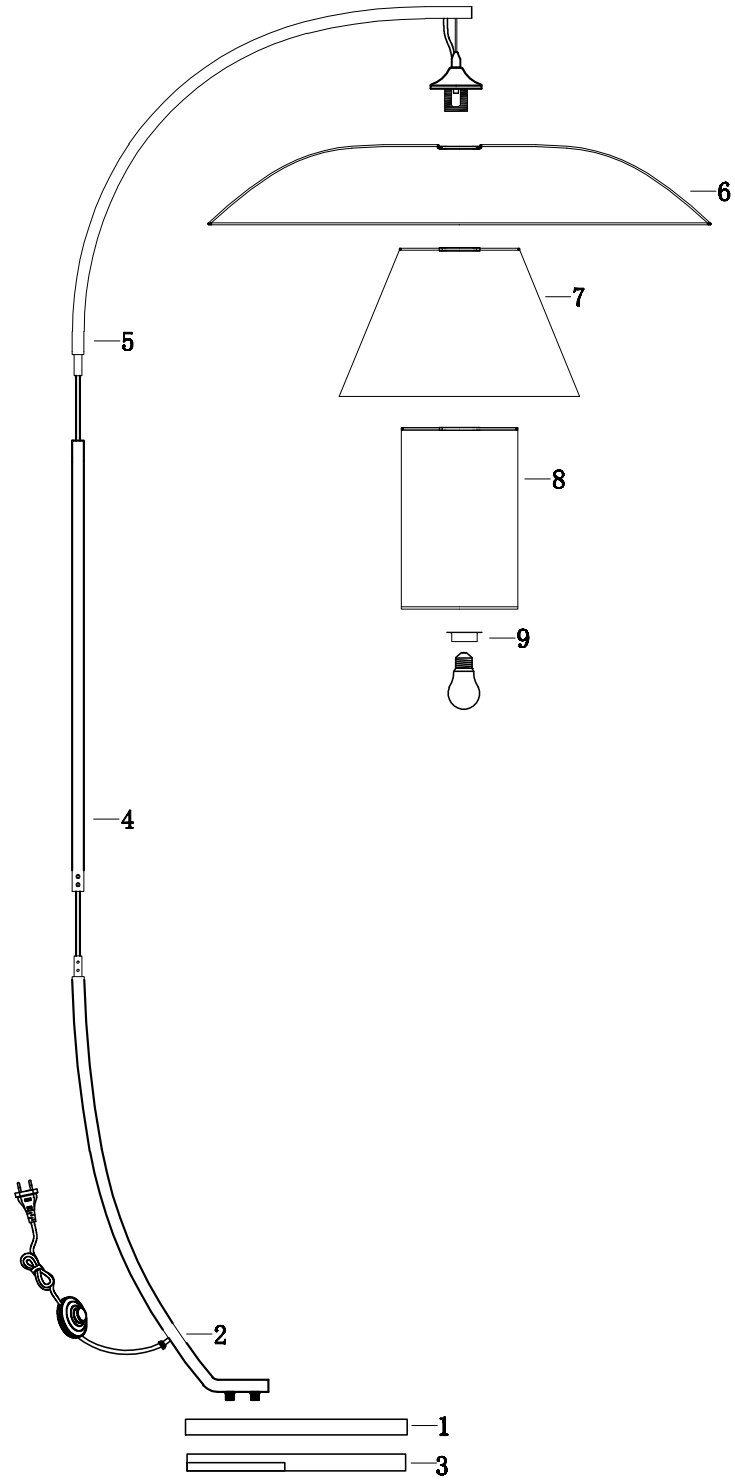

NOTICE DE MONTAGE / ASSEMBLY INSTRUCTIONS

Conserver l'emballage pour information - Informations à conserver / Keep the packaging for information - Keep this information for future reference





La Redoute	GNK186
Alimentation: 230V~50Hz E27 Max 40W Made in China	
   	
LA REDOUTE, 110 rue de blanchemaille, 59100 ROUBAIX	

1

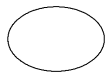

<p>A</p>  <p>ø 30*11.0mm</p> <p>2PCS</p>	<p>B</p>  <p>2PCS</p>	<p>C</p>  <p>1PCS</p>
<p>D</p>  <p>ø 343*11.0mm</p> <p>1PCS</p>	<p>E</p>  <p>ø 5/32*7mm</p> <p>4PCS</p>	<p>F</p>  <p>1PCS</p>

1

A  ø30*71.0mm 2PCS	B  2PCS	C  1PCS
D  ø343*71.0mm 1PCS	E  ø5/32*7mm 4PCS	F  1PCS

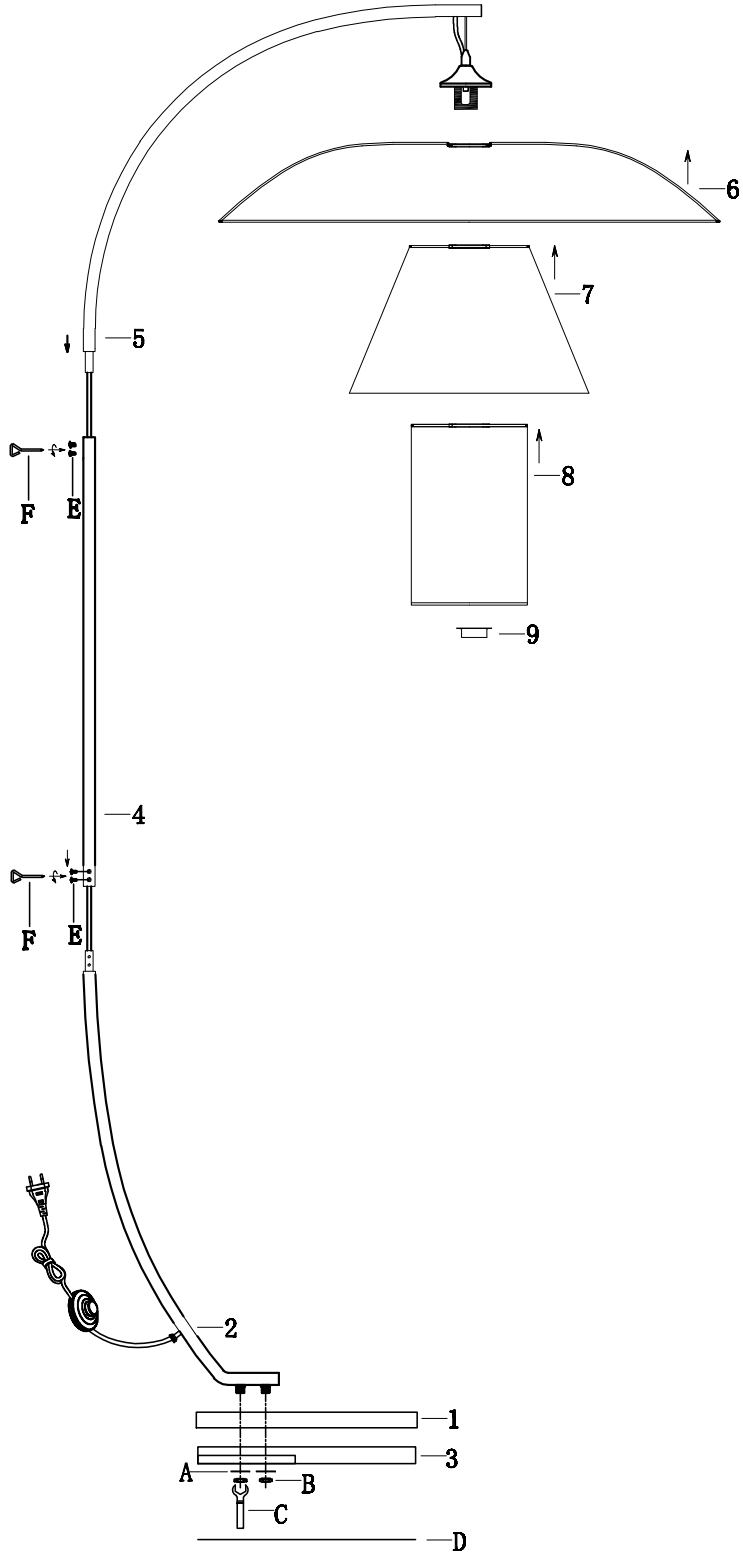

2

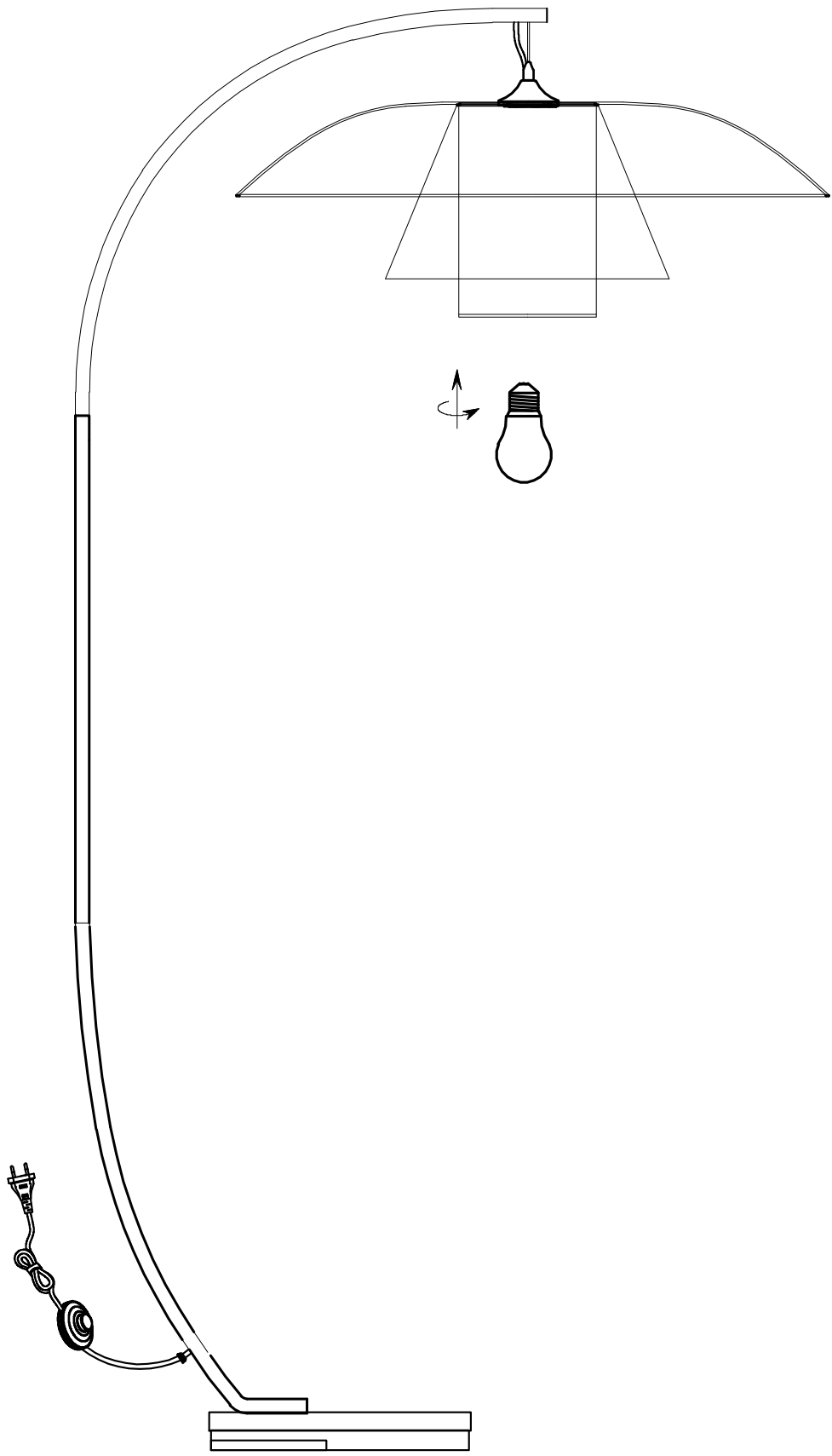

3

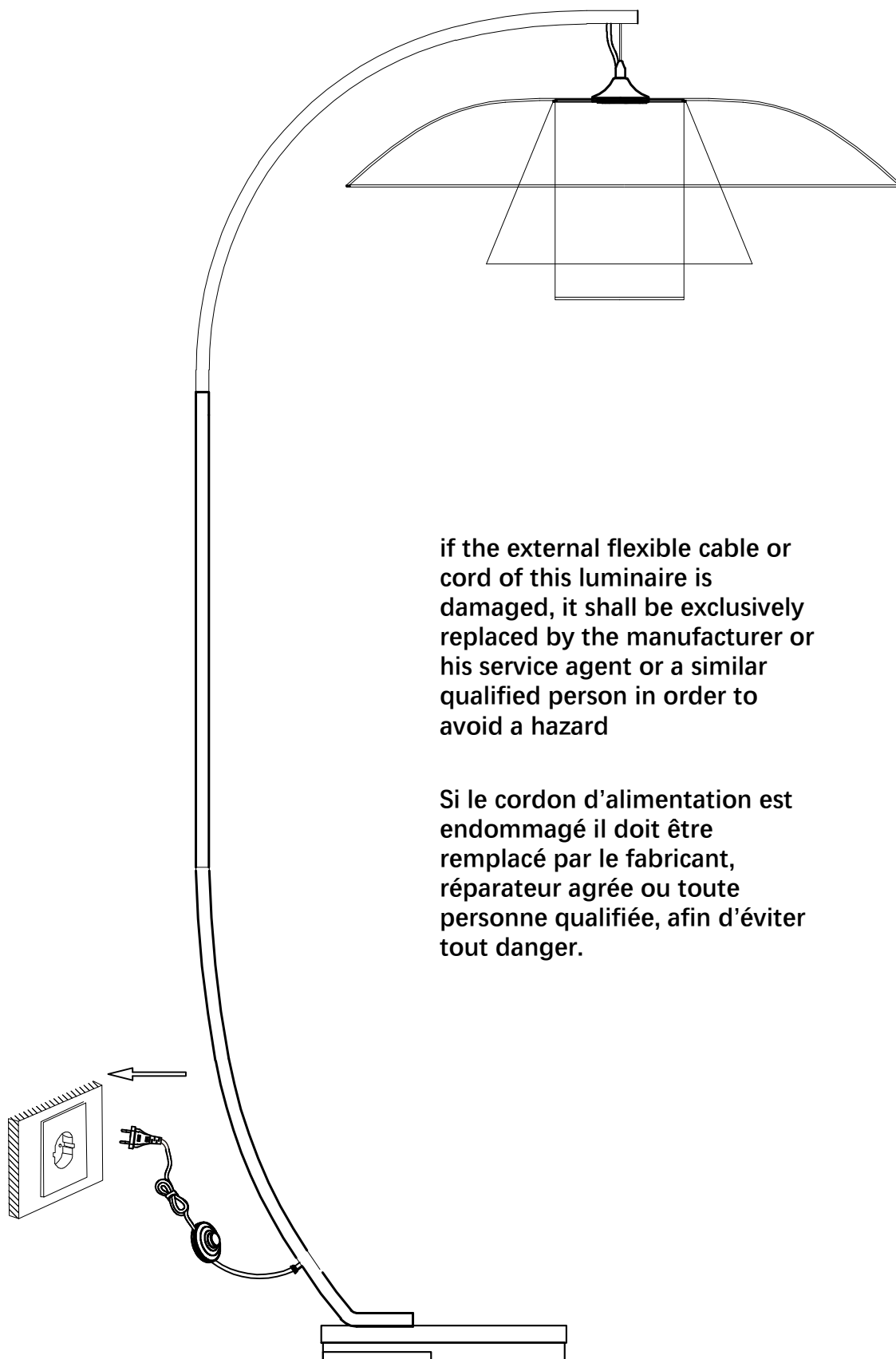

if the external flexible cable or cord of this luminaire is damaged, it shall be exclusively replaced by the manufacturer or his service agent or a similar qualified person in order to avoid a hazard

Si le cordon d'alimentation est endommagé il doit être remplacé par le fabricant, réparateur agréé ou toute personne qualifiée, afin d'éviter tout danger.

Informations à conserver / Information to be kept / Informationen aufbewahrt werden / Información que debe mantenerse / Belangrijke informatie om te bewaren / Informações importantes que é conveniente guardar / Informazioni da conservare

FR

Pour utilisation intérieur uniquement. Informations à conserver.

Lire attentivement la notice avant la première utilisation.

Si le cordon d'alimentation est endommagé il doit être remplacé par le fabricant, réparateur agréé ou toute personne qualifiée, afin d'éviter tout danger.

UK

For indoor use only. Information to be kept.

Read carefully the instruction sheet before first use.

If the external flexible cable or cord of this luminaire is damaged, it shall be exclusively replaced by the manufacturer or his service agent or a similar qualified person in order to avoid a hazard

DE

Nur für den Innenbereich. Informationen aufbewahrt werden.

Lesen Sie die Gebrauchsanweisung sorgfältig vor der Benutzung.

Wenn das externe flexible Kabel oder Kabel dieser Leuchte ist beschädigt, ist es ausschließlich durch den Hersteller ersetzt oder sein Serviceagent oder ein ähnliches qualifizierte Person, um.

ES

Sólo para uso en interiores. Información que debe mantenerse.

Lea atentamente la hoja de instrucciones antes del primer uso.

Si el Cable flexible externo o El cable de esta lámpara es Cuando se daña Sustituido por el fabricante o Su agente de servicio o similar Personal calificado Evitar el peligro.

NL

Belangrijke informatie om te bewaren.

Aandachtig lezen voor het eerste gebruik.

Indien de externe flexibele kabel of kabel van dit armatuur is beschadigd, wordt het uitsluitend vervangen door de fabrikant of zijn dienstverlenende agent of een soortgelijke gekwalificeerde persoon om een gevaar vermijden.

PT

Informações importantes que é conveniente guardar.

Ler atentamente antes da primeira utilização.

Se o cabo flexível externo ou O cabo desta luminária é danificada, deve ser exclusivamente substituído pelo fabricante ou o seu agente de serviço ou um similar pessoa qualificada para evitar um perigo.

IT

Solo per uso interno. Informazioni da conservare.

Leggere attentamente le istruzioni prima del primo utilizzo.

Se il cavo flessibile esterno o il cavo di questo apparecchio è danneggiato, deve essere esclusivamente sostituito dal fabbricante o il suo agente di servizio o un simile persona qualificata per evitare un pericolo.



Français

Le pictogramme de la poubelle barrée indique que le produit doit faire l'objet d'un tri. Il doit être recyclé conformément à la réglementation environnementale locale en matière de déchets. En triant les produits portant ce pictogramme, vous contribuez à réduire le volume des déchets incinérés ou enfouis, et à diminuer tout impact négatif sur la santé humaine et l'environnement.



English

The crossed-out wheeled bin symbol indicates that the item should be disposed of separately from household waste. The item should be handed in for recycling in accordance with local environmental regulations for waste disposal. By separating a marked item from household waste, you will help reduce the volume of waste sent to incinerators or land-fill and minimize any potential negative impact on human health and the environment.



Deutsch

Das Symbol mit der durchgestrichenen Abfalltonne bedeutet, dass das Produkt getrennt vom Haushaltsabfall entsorgt werden muss. Das Produkt muss gem. der örtlichen Entsorgungsvorschriften der Wiederverwertung zugeführt werden. Durch separate Entsorgung des Produkts trägst du zur Minderung des Verbrennungs- oder Deponieabfalls bei und reduzierst eventuelle negative Einwirkungen auf die menschliche Gesundheit und die Umwelt.



Nederlands

Het symbool met de doorgestreepte vuilnisbak op wieltjes geeft aan dat het product gescheiden van het huishoudelijk afval moet worden aangeboden. Het product moet worden ingeleverd voor recycling in overeenstemming met de plaatselijke milieuvoorschriften voor afvalverwerking. Door producten met dit symbool te scheiden van het huishoudelijk afval, help je de hoeveelheid afval naar verbrandingsovens of stortplaatsen te verminderen en eventuele negatieve invloeden op de volksgezondheid en het milieu te minimaliseren.



Español

La imagen del cubo de basura tachado indica que el producto no debe formar parte de los residuos habituales del hogar. Se debe reciclar según la normativa local medioambiental de eliminación de residuos. Cuando separas los productos que llevan esta imagen, contribuyes a reducir el volumen de residuos que se incineran o se envían a vertederos y minimizas el impacto negativo sobre la salud y el medio ambiente.



Português

O símbolo do caixote do lixo com o sinal de proibição indica que esse artigo deve ser separado dos resíduos domésticos convencionais. Deve ser entregue para reciclagem de acordo com as regulamentações ambientais locais para tratamento de resíduos. Ao separar um artigo assinalado dos resíduos domésticos, ajuda a reduzir o volume de resíduos enviados para os incineradores ou aterros, minimizando o potencial impacto negativo na saúde pública e no ambiente.



Italiano

Il simbolo del cassonetto barrato indica che il prodotto non può essere eliminato con i comuni rifiuti domestici. Il prodotto dev'essere riciclato nel rispetto delle norme ambientali locali per lo smaltimento dei rifiuti. Separando un prodotto contrassegnato da questo simbolo dai rifiuti domestici, aiuterai a ridurre il volume dei rifiuti destinati agli inceneritori o alle discariche, minimizzando così qualsiasi possibile impatto negativo sulla salute umana e sull'ambiente.