

# La Redoute

♦ INTERIEURS ♦

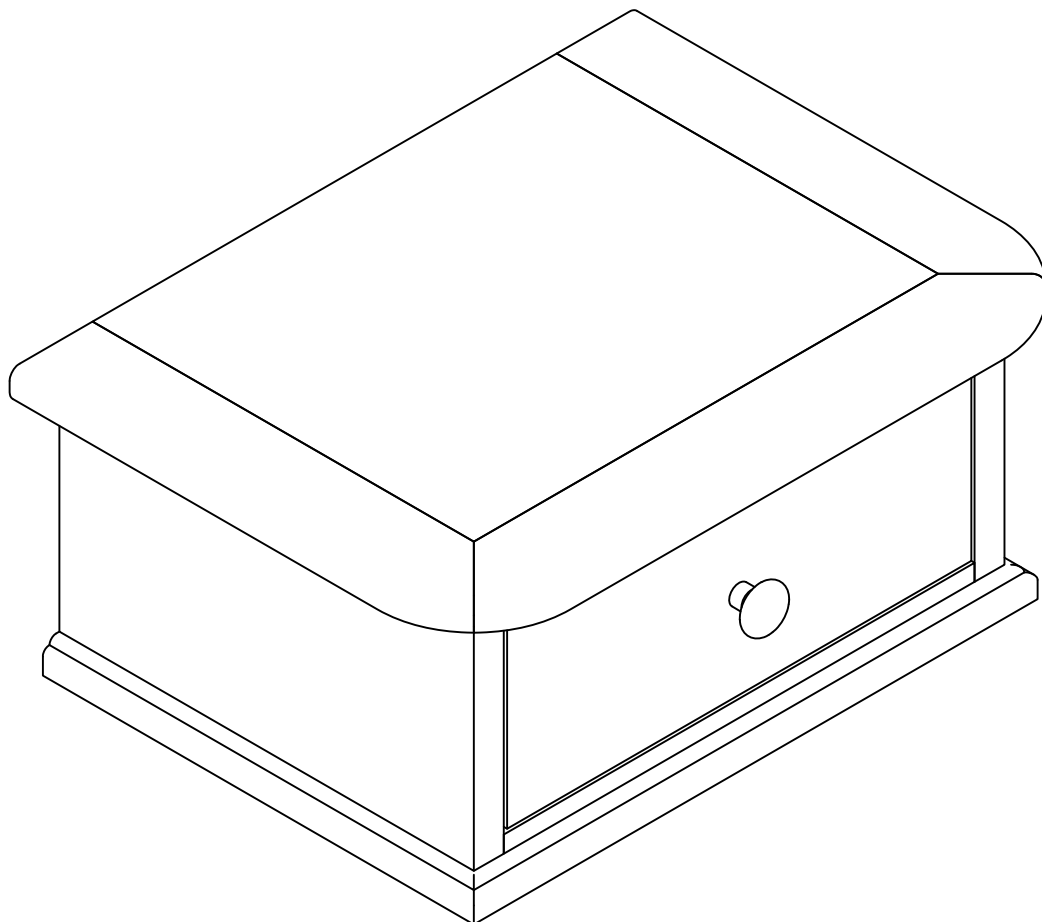

FACILE - EASY  
LEICHT - FÁCIL

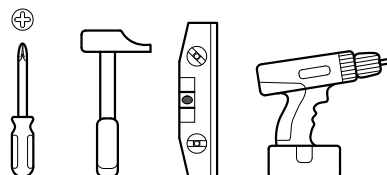
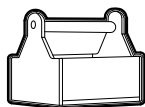
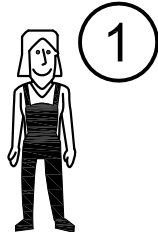

FR / Si vous avez des questions sur votre produit, email : [sitegsm@redoute.fr](mailto:sitegsm@redoute.fr) ou appeler au : 0 969 323 515

UK / If you need information about your product, email [elpline@redoute.co.uk](mailto:elpline@redoute.co.uk) or call: 033 0303 0199

CH / Wenn Sie Fragen zu Ihrem Produkt, email : [info@redoute.ch](mailto:info@redoute.ch) oder anrufen : FR/IT : 0848 848 505, DE: 0848 848 505

BE / Si vous avez des questions sur votre produit, email : [serviceclient@redoute.be](mailto:serviceclient@redoute.be) ou appeler : 056 85 15 15 - Als u vragen over uw product, email : [klantendienst@redoute.be](mailto:klantendienst@redoute.be) of bel : 056 85 15 00

ES / Si tiene alguna pregunta acerca de su producto, email : [contacto@lare-doute.es](mailto:contacto@lare-doute.es) o llamar : 902 33 00 33

PT / Se você tiver dúvidas sobre o seu produto, email: [contacto@redoute.pt](mailto:contacto@redoute.pt) ou chamar: 707201010

SE / Om du har frågor om din produkt, email : [service@laredoute.se](mailto:service@laredoute.se) eller ring : 033 - 48 20 00

NW / Hvis du trenger informasjon om produktet, email: [service@laredoute.no](mailto:service@laredoute.no) eller telefon: 66-89-15-00

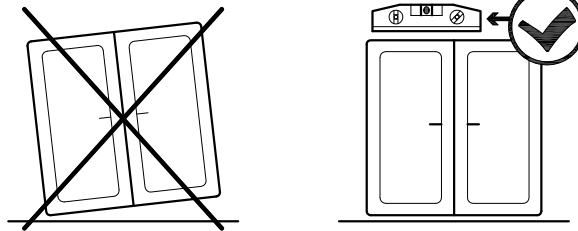
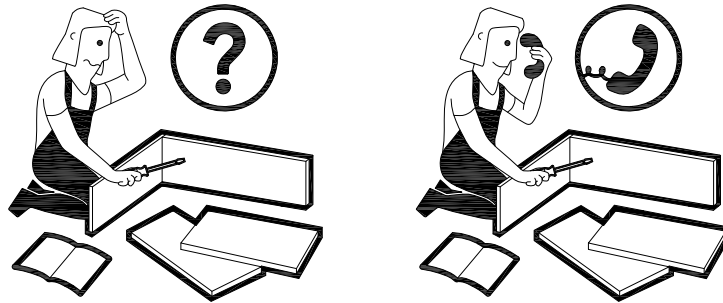

FR - Nous vous remercions pour votre achat. Nous espérons que ce produit répondra pleinement à vos attentes et vous satisfera au quotidien.

---

---

#### AVERTISSEMENT DE SECURITE

Information importante si votre meuble est muni d'une attache murale  
En cas de chute du meuble, il y a un risque de blessures graves. Pour éviter que le meuble ne bascule, il faut le fixer au mur de façon permanente.  
Les fixations murales ne sont pas incluses car leur choix dépend du matériau du mur.  
Nous vous conseillons alors de vous adresser à un revendeur spécialisé pour obtenir des conseils sur les fixations adaptées à votre type de mur.

#### CONSEILS AVANT MONTAGE

Contrôlez le contenu de votre colis avant de procéder au montage.  
Assemblez ensuite le meuble en suivant l'ordre défini par la notice et si possible dans la pièce de destination.

DE - Vielen Dank für Ihren Einkauf.  
Wir hoffen, dass dieses Produkt wird voll und ganz erfüllen Ihre Anforderungen und erfüllen Sie im Alltag.

---

---

#### ACHTUNG

Wichtige Informationen, wenn Ihr Schrank hat einen Maueranker  
Bei Möbel umkippen, besteht die Gefahr von schweren Verletzungen. Damit das Gehäuse vor dem Umkippen zu verhindern, müssen wir die permanente Wand zu befestigen.  
Wandhalterungen sind nicht enthalten, da ihre Wahl hängt von der Wandmaterial. Wir empfehlen Ihnen, die Sie an einen Fachhändler um Rat, Anhänge für Ihre Wand Typ angepasst beziehen.

#### VOR DER MONTAGE

Überprüfen Sie den Inhalt des Pakets vor der Installation.  
Montieren Sie die Möbel in der durch das Protokoll festgelegten Reihenfolge.

PT - Agradecemos a sua compra.  
Esperamos que este produto satisfaça plenamente as suas necessidades e seja um valioso contributo para o seu quotidiano.

---

---

#### AVISO DE SEGURANÇA

Informação Importante caso o seu artigo esteja preparado para fixar à parede  
A eventual queda de móveis, representa o risco de ferimentos graves. Para evitar que o móvel tombe, deve ser convenientemente fixado a uma parede.  
Os suportes de parede não estão incluídos porque a sua escolha depende do material da parede. Aconselhamos que consulte um vendedor especializado para se aconselhar relativamente aos suportes adequados para o seu tipo de parede.

#### ANTES DA MONTAGEM

Verifique o conteúdo da embalagem antes da instalação.  
Montar os móveis na ordem indicada pelas instruções.

SE - Tack för ditt köp. Vi hoppas att denna produkt kommer att fullt ut uppfyller dina krav och tillfredsställa dig i vardagen

---

---

#### SÄKERHETSVARNING

Viktig information om ditt skåp har en vägg slips  
Vid möbler falla, finns det en risk för allvarlig skada. För att förhindra att skåpet tippar, måste vi fixa permanent väggen.  
Väggkonsoler ingår inte eftersom deras val beror på väggmaterialet. Vi råder dig att hänvisa dig till en auktoniserad återförsäljare för råd om tillbehör anpassade för din vägg typ.

#### FORE MONTERING

Kontrollera innehållet i förpackningen före installationen.  
Montera sedan möblerna i den ordning som definieras av posten.

UK - We thank you for your purchase.  
We hope this product will satisfy you in everyday life.

---

---

#### IMPORTANT SECURITY WARNING

Important information if your furniture is equipped with an anti-tipping device  
In case of furniture tip-over, there is a risk of serious crushing injuries. To prevent the furniture from tipping-over, it must be permanently fixed to the wall.  
Wall fixing devices are not included since their choice depends on the wall material. We advise you to refer you to a specialized dealer for advice on suitable fixing systems for your wall type.

#### BEFORE ASSEMBLY

Check the contents of your package prior to assemble your furniture.  
Assemble then the furniture in the order defined by the assembly instruction

ES - Muchas gracias por adquirir este producto. Esperamos que estés satisfecho/a con tu compra y que este producto responda plenamente a tus necesidades.

---

---

#### AVISO DE SEGURIDAD

Información importante si tu mueble tiene sujeción a la pared.  
En el caso de que el mueble caiga, existe el riesgo de heridas graves. Para evitar que el mueble se mueva, hay que fijarlo de forma permanente a la pared.  
Las piezas de fijación a la pared no están incluidas porque su elección depende del tipo de material de la pared. Te aconsejamos que te dirijas a un vendedor especializado que te aconseje sobre las piezas más adecuadas para tu tipo de pared.

#### ANTES DEL MONTAJE

Comprueba el contenido del paquete antes de empezar el montaje.  
Monta el mueble de inmediato siguiendo el orden definido en las instrucciones.

NL - Dank u voor uw aankoop. We hopen dat dit artikel volledig aan uw wensen zal voldoen.

---

---

#### VEILIGHEIDSWAARSCHUWING

Belangrijke informatie indien uw meubel aan de muur bevestigd moet worden.  
Bij het vallen van meubels kunnen er ernstige letsels ontstaan. Om te vermijden dat het meubel kantelt, moet het goed bevestigd worden aan de muur of wand.  
Muurbevestigingen zijn niet inbegrepen omdat de keuze daarvan afhangt van het soort wand. Wij raden u aan om een specialist te raadplegen ivm het type bevestigingen voor uw type wand.

#### VÓÓR DE MONTAGE

Controleer de inhoud van het pakket voor de installatie.  
Monteer vervolgens het meubel door de handleiding te volgen.

NW - Takk for kjøpet. Vi håper dette produktet vil fullt ut oppfyller dine krav og tilfredsstille deg i hverdagen.

---

---

#### SIKKERHET

Viktig informasjon om kabinettet har en vegg tie  
Ved møbler fall, er det en risiko for alvorlig skade. For å hindre at kabinettet tipper, må vi fikse permanent vegg. Veggbraketter er ikke inkludert fordi deres valg avhenger av veggmaterialet. Vi anbefaler deg å henvise deg til en spesialist forhandler for råd om vedlegg tilpasset din veggtype.

#### FØR MONTERING

Sjekk innholdet i pakken før installasjonen.  
Monter deretter møblene i den rekkefølgen definert av posten.

A x2

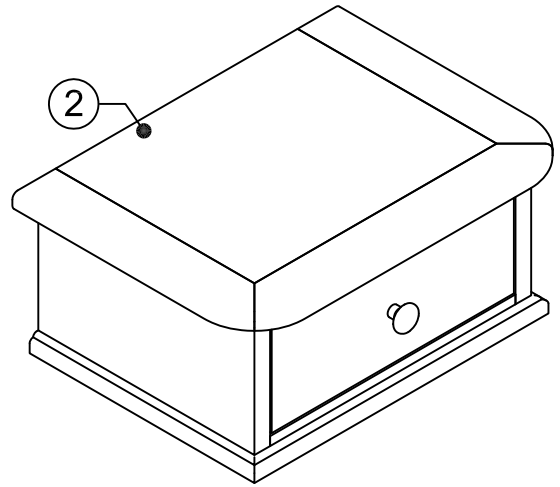
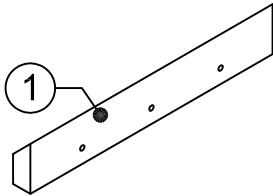

1

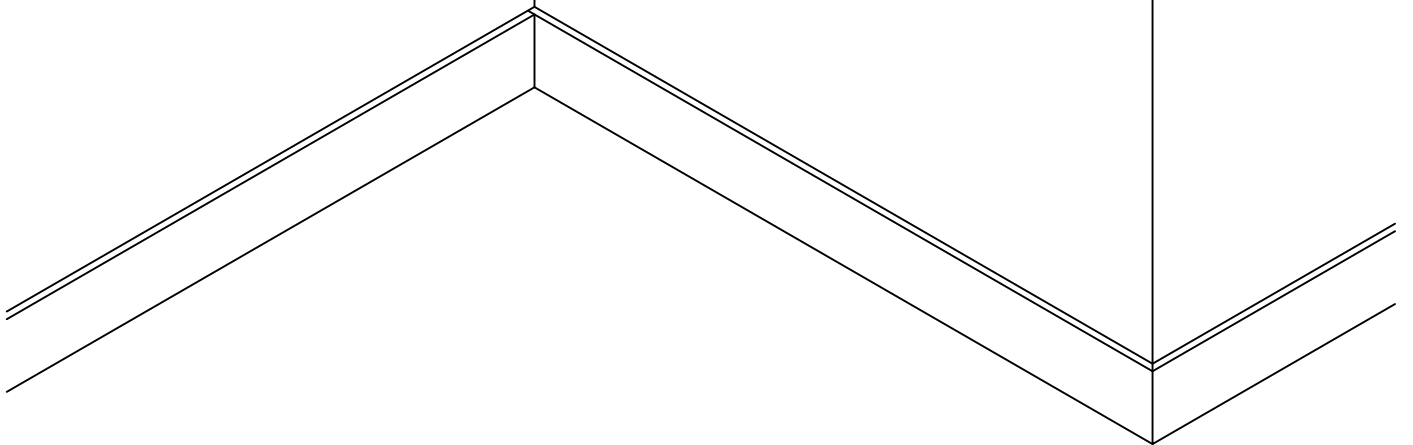
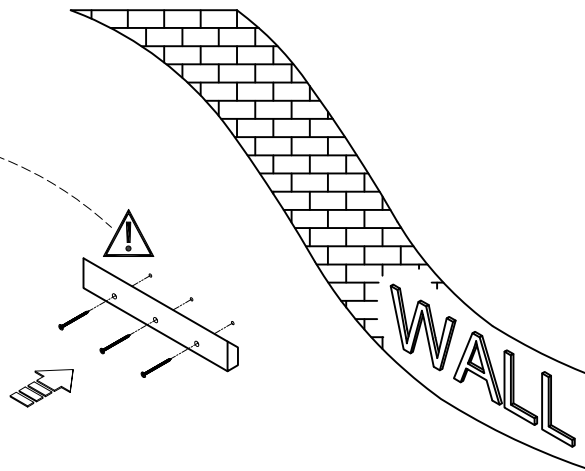
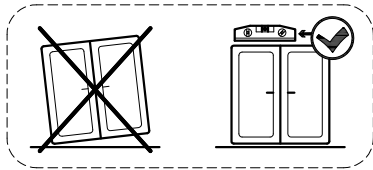

2

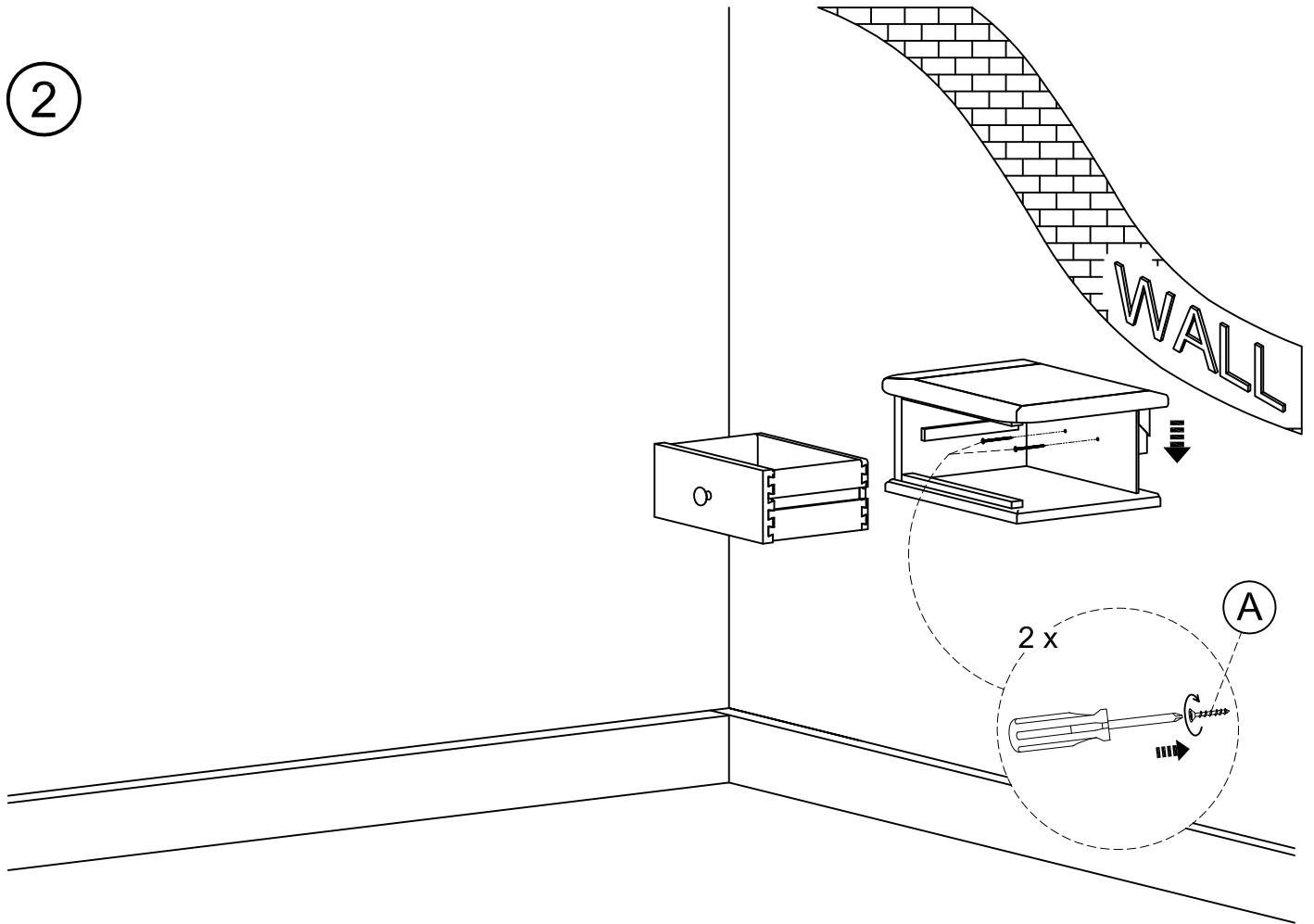

3

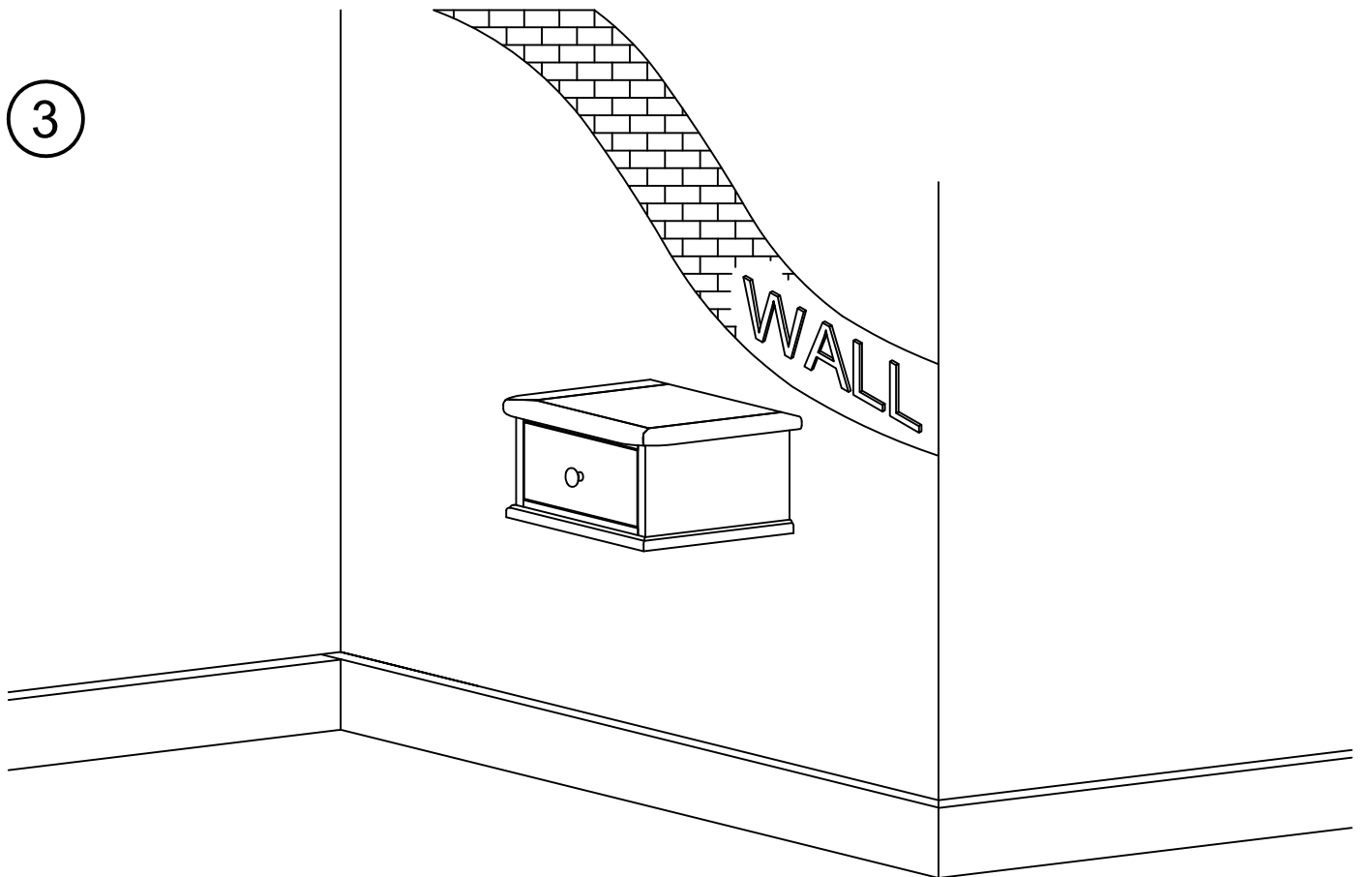

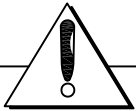

Il existe une grande diversité de types de murs ou cloisons. C'est la raison pour laquelle nous ne pouvons vous fournir le type exact de fixation. Il est nécessaire d'identifier le type de type de paroi à laquelle vous allez fixer ce produit afin de vous procurer les fixation appropriées. Voici quelques exemples de fixation conseillées pour:

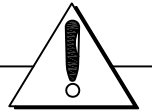

### LES MURS PLEINS

CHEVILLE NYLON  
"FISCHER"

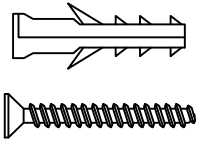

CHEVILLE D'ANCRAGE  
MÉTAL

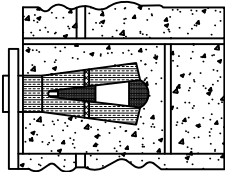
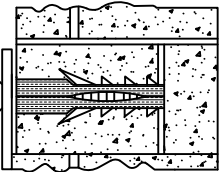
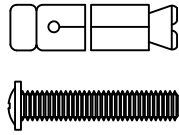

### LES CLOISONS CREUSES

CHEVILLE D'ANCRAGE  
A AILETTES EN NYLON

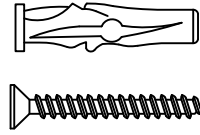

CHEVILLE D'ANCRAGE  
A AILETTES EN NYLON

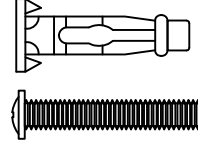

CHEVILLE "MOLLY"

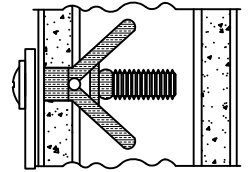
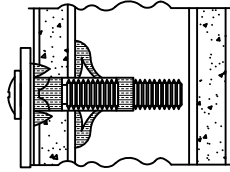
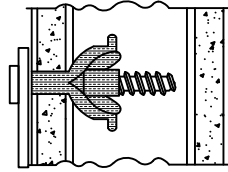
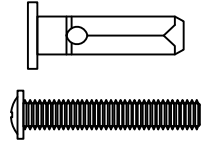

Utiliser une taille de forêt adaptée à la quincaillerie utilisée et au type de mur

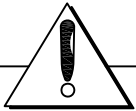

Due to the wide diversity of wall or partition types, we cannot provide you with suitable attachment fixtures. To determine which attachment fixtures to use, you will need to identify the type of wall to which you will be fixing this product. Here are some examples of attachment fixtures recommended for:

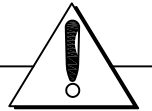

### BLIND WALLS

"FISCHER"  
Nylon plug

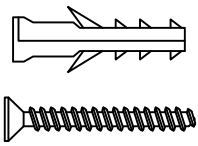

Metal  
Wall plug

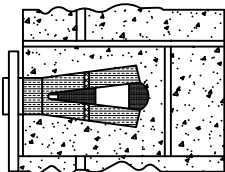
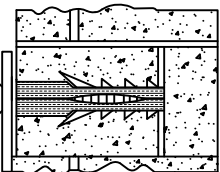
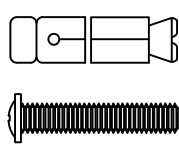

### STUDDED WALLS

Nylon winged  
Wall plug

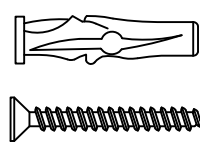

Metal expansion  
plug

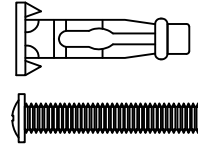

"MOLLY" plug

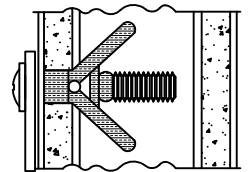
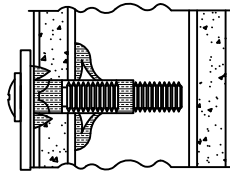
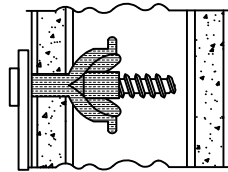
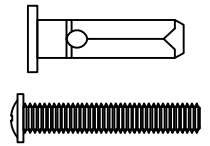

Use a drill bit that is compatible in size with the hardware used and the type of wall



Devido ao diversity largo da parede ou da divisória datilografica, nós não pode fornecê -lo com os dispositivos elétricos apropriados do acessório. A determinar que dispositivos elétricos se usar, você do acessório necessitará identificar o tipo de parede a que você estará reparando este produto. Está o aqui alguns exemplos dos dispositivos elétricos do acessório recomendados para:



### PAREDES CEGAS

"FISCHER"  
Plugue de nylon

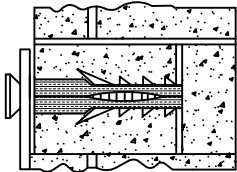
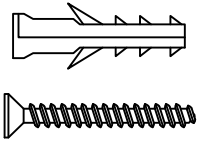

Metal  
Plugue de parede

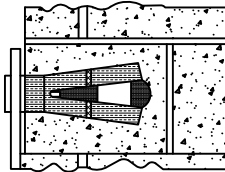
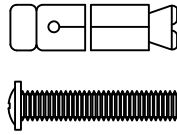

Nylon voado  
Plugue de parede

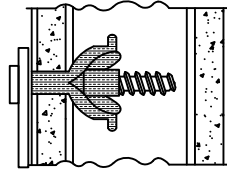
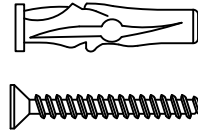

### PAREDES STUDDED

Expansã o do metal plugue

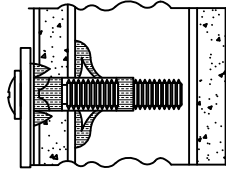
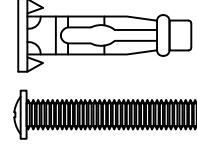

Plugue do  
"MOLLY"

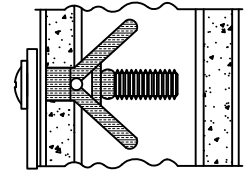
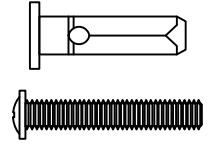

Usar um bocado de broca que seja compatí vel no tamanho com a ferragem usada e o tipo de parede

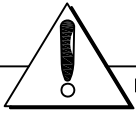

Door brede devversity van de muur of van de wand typt, wij kunnen iede aangewezen montages niet leveren d'attachement. Aan bepalen van welke montages d'attachement gebruiken, u behoeftezal hebben om het soort muur te identificeren waaraan u zult bepalen dit product. Ziehier enkele voorbeelden van de montagesd' attachement die voor worden aanbevolen



### BLINDE MUREN

"FISCHER"  
Nemen in nylon

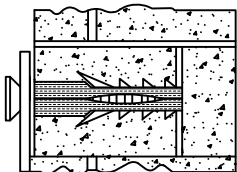
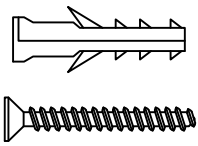

Metaal  
Nemen van muur

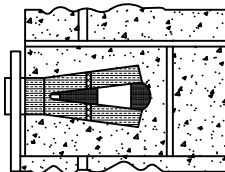
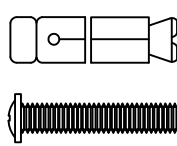

Het weggevlogen nylon s'est  
Nemen van muur

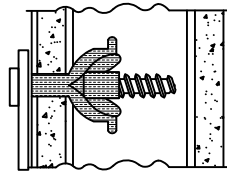
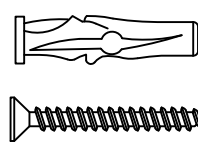

### BESLAGEN MUREN

Expansie in metaal  
nemen

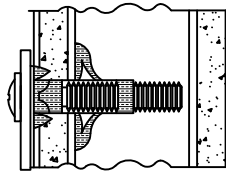
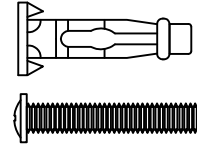

Nemen van "MOLLY"

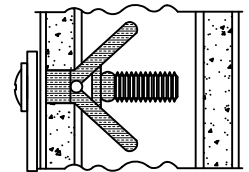
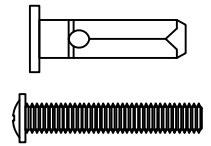

Een een beetje boor gebruiken die verenigbaar in de omvang met hetgebruikte materiaal is en het soort muur