

NOTICE DE MONTAGE / ASSEMBLY INSTRUCTIONS



Avertissement! / Warning!

F A monter par un adulte. Contrôler le contenu de votre colis avant de procéder au montage. Attention: tenir les vis et petits éléments et sachets hors de portée des enfants. Ne déroutez pas l'emballage, il vous sera très utile pour protéger les éléments des coups et rayures pendant le montage. Assemblez ensuite l'article en suivant l'ordre défini par la numérotation. Pour une utilisation à l'intérieur uniquement. Respecter l'ampoule recommandée. Il est impératif de couper le circuit électrique avant toute opération. Toujours débrancher la lampe et attendre 10 minutes avant toute opération. Fabriqué en Chine

GB To be assembled by an adult. Check the content of your parcel before assembling. Caution : Keep all screws, small parts and plastic bag out of the reach of small children. Do not throw away the packing which could be very useful to protect the panels from knocks and scratches when assembling. Assemble the article following the order of the numbers indicated. For indoor use only. To respect the bulb recommended. Cut the electric circuit before all operations. Always switch off the electricity supply and allow to cool for 10 minutes before modifications. made in China.

Ref: GKH456 (P0609-1W)

NOTICE DE MONTAGE / ASSEMBLY INSTRUCTIONS

Conserver l'emballage pour information - Informations à conserver / Keep the packaging for information - Keep this information for future reference



1



20 min



LED E14,4W
(non incluses)

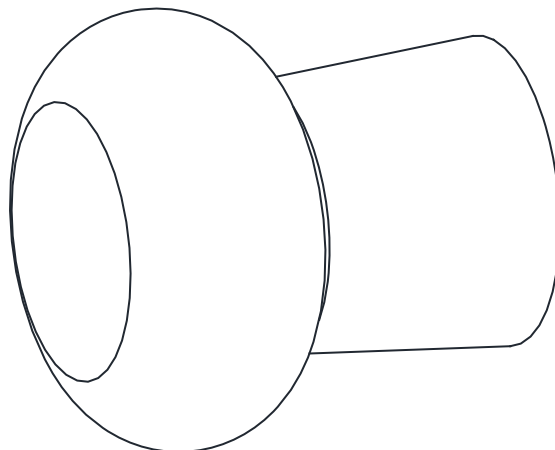

1 / 4

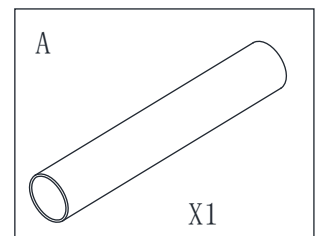

NOTICE DE MONTAGE / ASSEMBLY INSTRUCTIONS

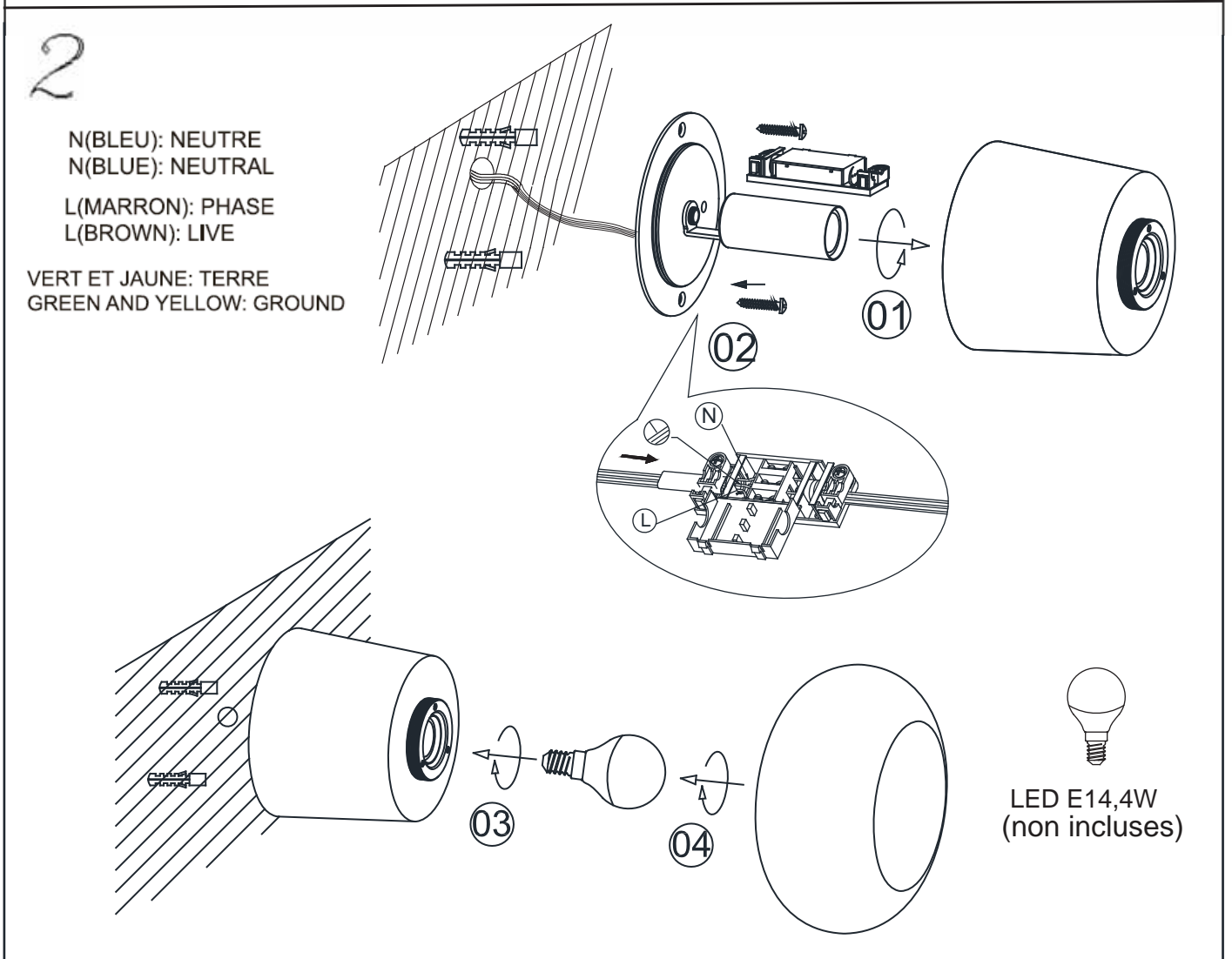
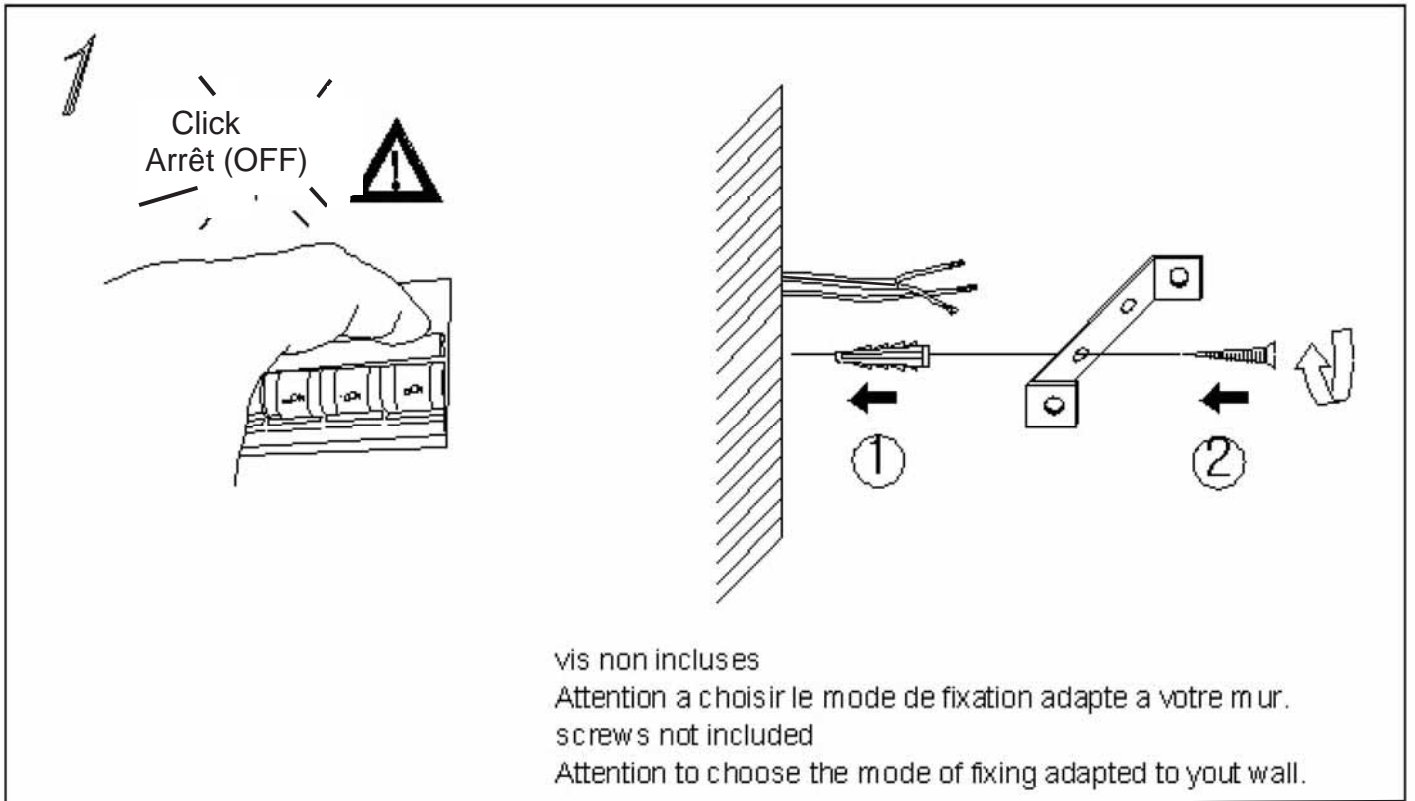

NOTICE DE MONTAGE / ASSEMBLY INSTRUCTIONS

“Warning: this drawing is for reference only. If the configuration of your bathroom is different than the one shown on this drawing, we strongly suggest you to contact a professional electrician to perform the correct installation according standard NFC15-100 “

“ Avertissement: ce schéma est donnée uniquement à titre d'exemple. Si la configuration présentée sur le schéma ne correspond pas à celle de votre salle de bain, nous vous suggérons fortement de **contacter un électricien professionnel pour réaliser l'installation adéquate selon la norme NF C 15-100.**

This lamp must be supplied through a residual current device (RCD) having a rated residual operating current not exceeding 30 mA.

Ce luminaire doit être alimenté par l'intermédiaire d'un dispositif à courant différentiel résiduel (DDR) ayant un courant différentiel de fonctionnement assigné ne dépassant pas 30 mA.

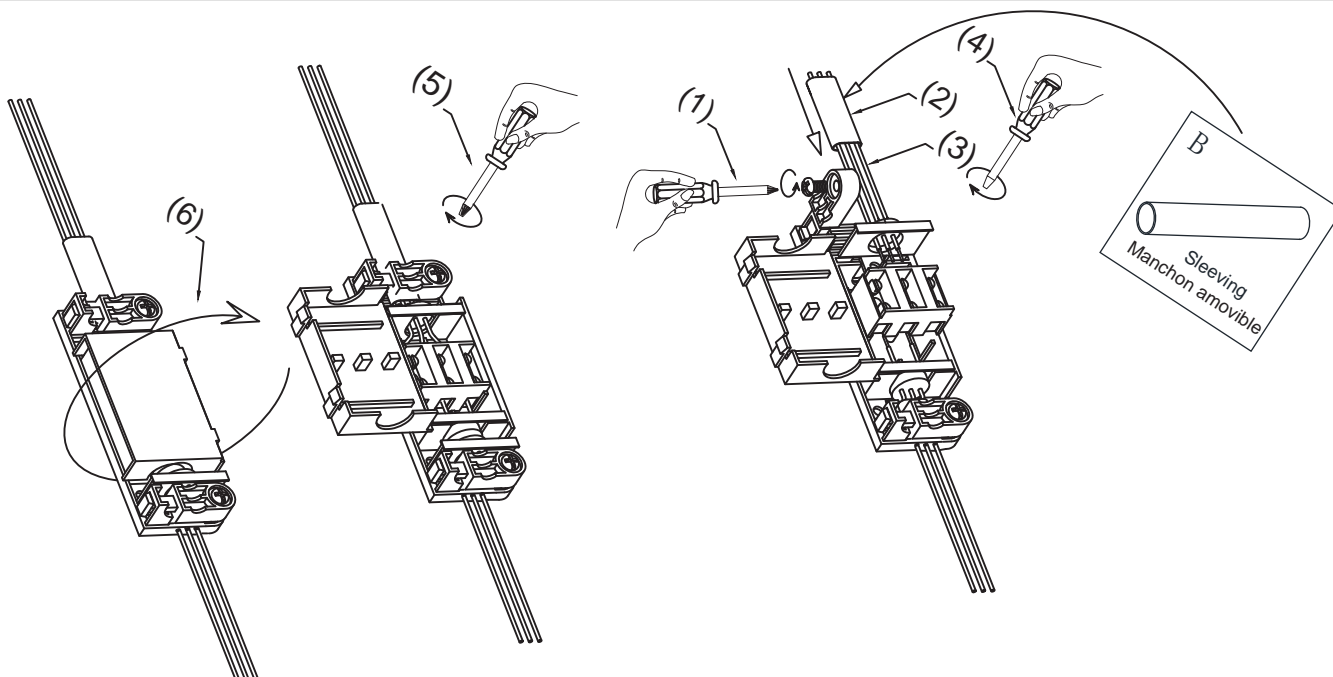
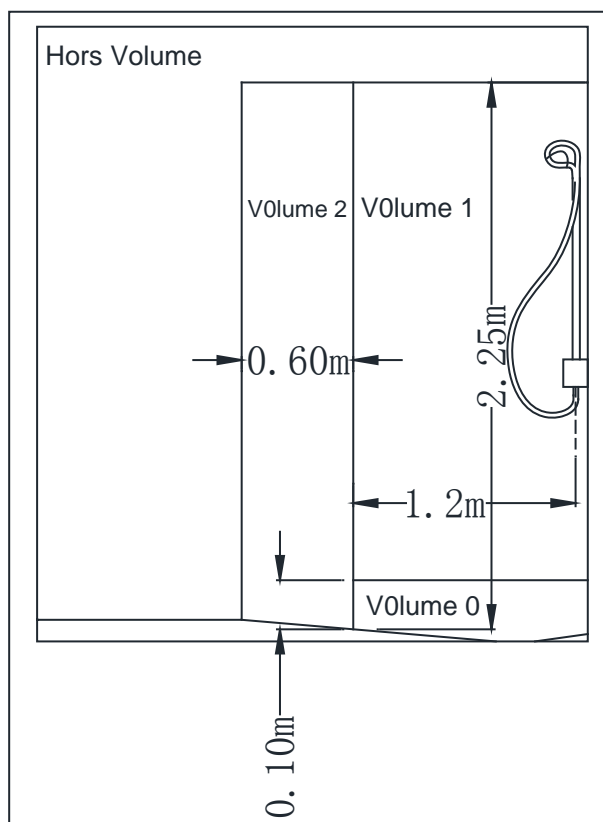
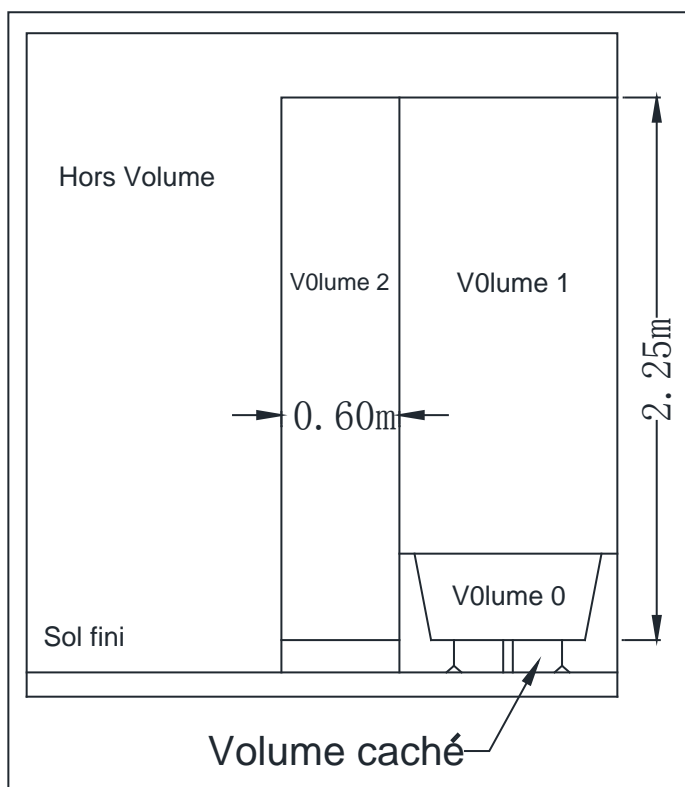

NOTICE DE MONTAGE / ASSEMBLY INSTRUCTIONS

BRANCHEMENT

Attention: Veuillez à couper l'arrivée du courant de votre installation électrique (disjoncteur, boîte à fusible) avant de raccorder votre luminaire.

Denudez ensuite les fils sur 5mm environ, passez les dans le manchon amovible et réalisez les connexions comme indiqué ci-contre à l'aide du boîtier de raccordement. Serrez fermement les vis, remplacez le bornier dans le boîtier et refermez le (clips).

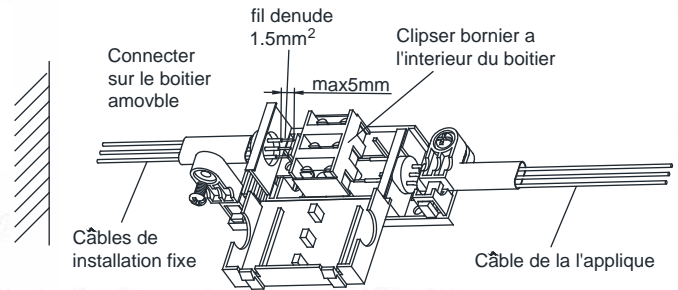







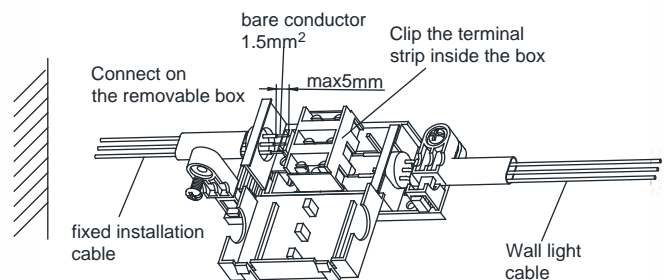

CONNECTION

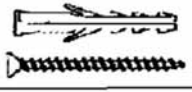
Warning: be careful to turn the electricity off at the mains (via circuit-breaker or fuse box) before connecting your light fitting.

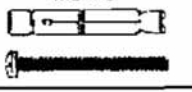
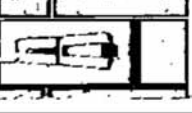
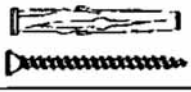
The bare conductor approximately 5 mm at the end of fixed installation cable. insert them in the removable sleeve and make the connections as indicated opposite using the connection box. Tighten the screws firmly, put the terminal strip back in the box and close the (clip).

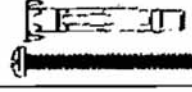





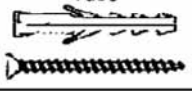

! Il existe une grande diversité de type de murs ou cloisons, c'est la raison pour laquelle nous ne pouvons vous fournir le type exact de fixation. Il est nécessaire d'identifier le type de paroi à laquelle vous allez fixer votre produit afin de vous procurer les fixations appropriées, voici quelques exemples de fixations conseillées. !

LES MURS PLEINS		LES CLOISONS CREUSES		
CHEVILLE NYLON FISHER  	CHEVILLE D'ANCRAGE MÉTAL  	CHEVILLE D'ANCRAGE À AILETTES EN NYLON  	CHEVILLE MÉTALLIQUE À EXPANSION  	CHEVILLE MOLLY  

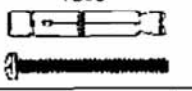
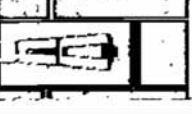
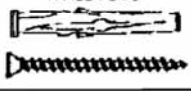
Utiliser une taille de foret adaptées à la quincaillerie utilisée et au type de votre mur

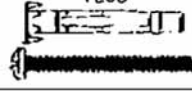
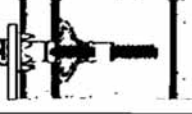
! Due to wide diversity of wall or partition types, we cannot provide you with suitable attachment fixtures. To determine which attachment fixtures to use, you will need to identify the type of wall to which you will be fixing this product. Here are some examples of recommended attachment fixtures. !

SOLID WALLS		HOLLOW PARTITIONS		
FISHER NYLON PLUG  	METAL WALL PLUG  	NYLON WINGED WALL PLUG  	METAL EXPANSION PLUG  	MOLLY PLUG  

use a drill that is compatible in size with the hardware used and the type of wall