

CD524
241.4775

AM.
PM.

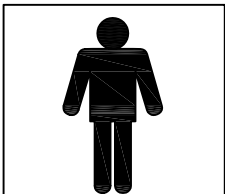
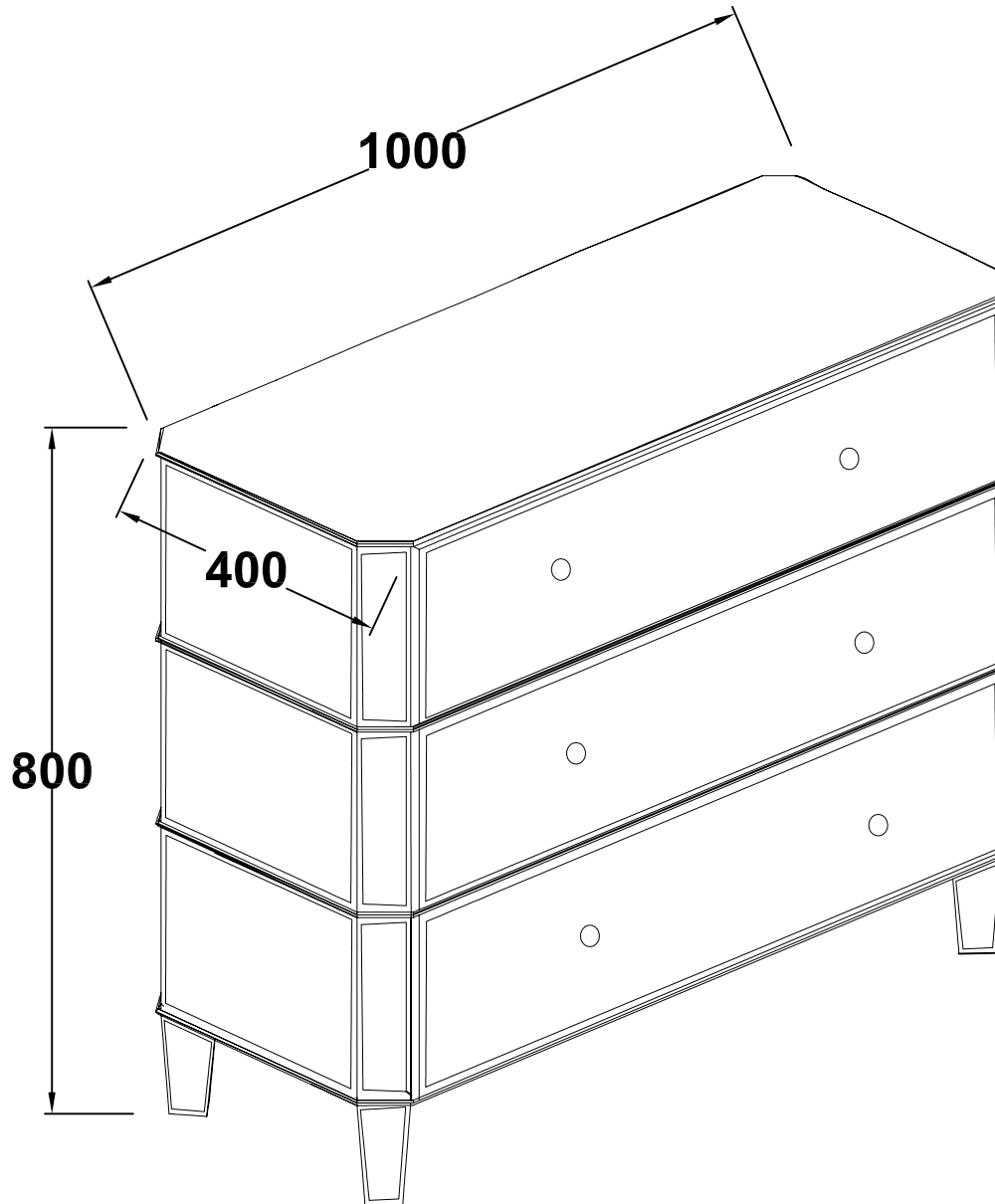

- Contrôlez le contenu de votre colis avant de procéder au montage.
- Ne défilez pas l'emballage, il vous sera très utile pour protéger les éléments des coups ou rayures pendant le montage.
- Assemblez ensuite le meuble en suivant l'ordre défini par la numérotation.
- En cas de problème contactez notre Service Après-Vente.
- A réception, aérer vos meubles, portes et tiroirs ouverts, dans une pièce bien ventilée. Renouveler régulièrement l'air de vos pièces.

- Check the content of your parcel before assembling.
- Do not throw away the packing which could be very useful to protect the panels from knocks and scratches when assembling.
- Assemble the article following the order of the numbers indicated.
- Should any problems arise, please contact our After Sale Service.
- Upon receipt, place the furniture in a well-ventilated room and leave doors and drawers open to allow the air to circulate. Change the air in your rooms on a regular basis.

- Vor Montage den Inhalt Ihres Packchens kontrollieren
- Die Verpackung nicht zerstören, sie wird Ihnen nützlich sein, um die Teile bei der Montage vor Stößen und Kratzern zu schützen
- Das Möbel dann in der Reihenfolge der Nummerierung zusammenbauen
- Im Problemfall Ihren Kundendienst anrufen
- Lüften Sie Ihre Möbel nach dem Aufbau bitte mit geöffneten Möbeltüren und-schubladen in einem gut durchlüfteten Raum. Bitte belüften Sie Ihre Wohnräume regelmäßig.

- Confira o conteúdo da sua encomenda antes de iniciar a montagem.
- Proceda à montagem do móvel seguindo a ordem definida pela numeração.
- Não danifique a embalagem, poderá ser-lhe útil para proteger os elementos de golpes ou riscos durante a montagem.
- Para qualquer esclarecimento, contacte os nossos serviços através do telefone.
- Aquando da sua recepção, arejar os seus móveis, portas e gavetas abertos, numa divisão bem ventilada. Renover regularmente o ar das suas divisões.

CD524

1

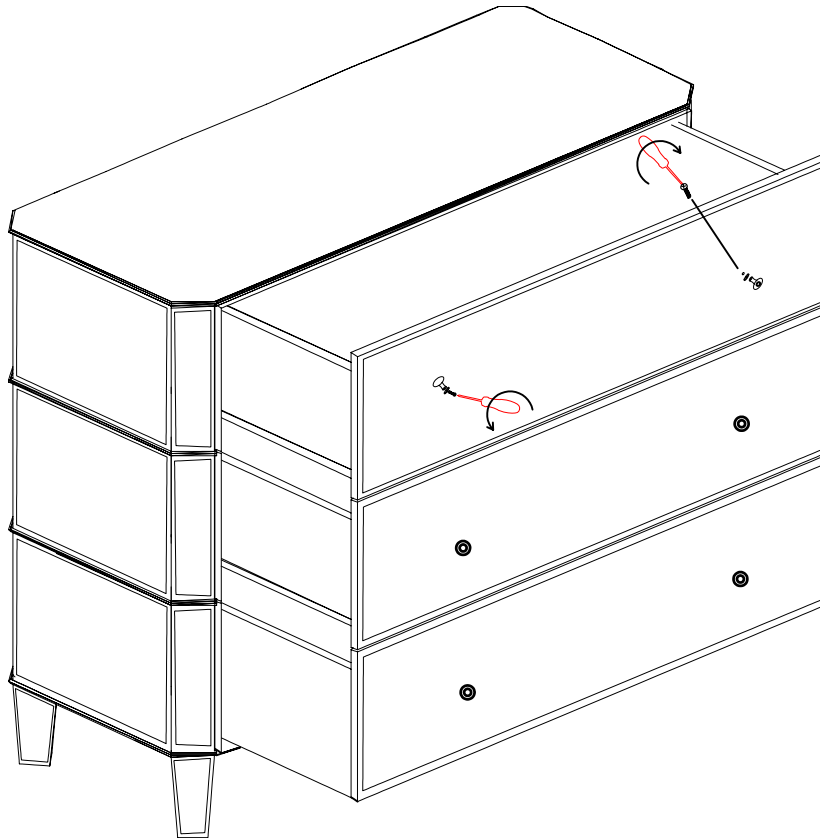

2

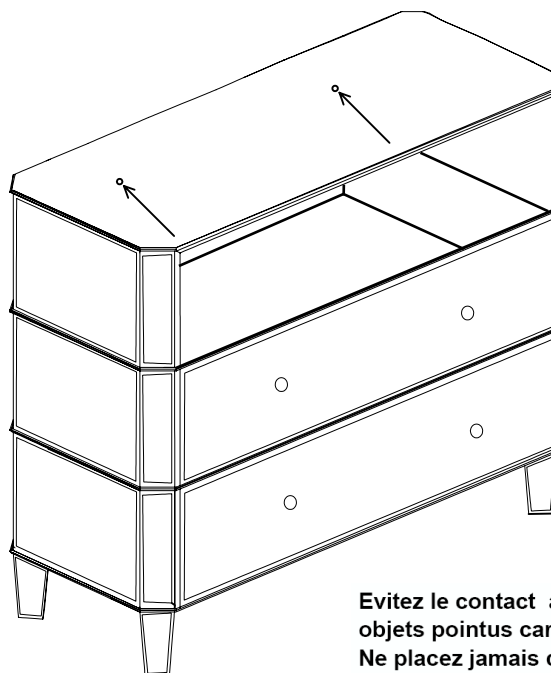

Evitez le contact avec des matières abrasives et des objets pointus car ils peuvent endommager la surface. Ne placez jamais des articles chauds directement sur le produit.

Avoid contact with abrasive materials and sharp objects as they can damage the surface. Please use place mats and never place hot items directly onto the product.



Il existe une grande diversité de types de murs ou cloisons. C'est la raison pour laquelle nous ne pouvons vous fournir le type exact de fixation. Il est nécessaire d'identifier le type de paroi à laquelle vous allez fixer ce produit afin de vous procurer les fixations appropriées. Voici quelques exemples de fixation recommandées pour:



LES MURS PLEINS

CHEVILLE NYLON
"FISCHER"

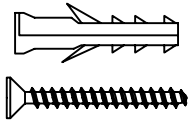

CHEVILLE D'ANCRAGE
MÉTAL

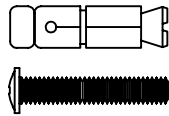

CHEVILLE D'ANCRAGE
A AILETTES EN NYLON

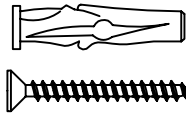

LES CLOISONS CREUSES

CHEVILLE D'ANCRAGE
A AILETTES EN NYLON

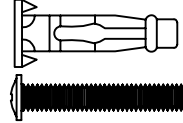

CHEVILLE "MOLLY"

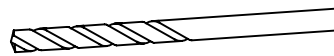
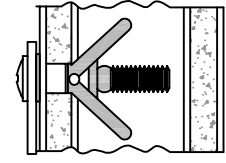
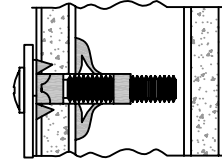
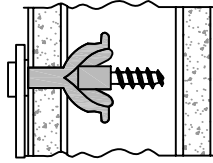
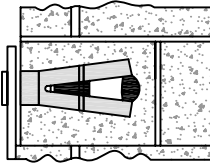
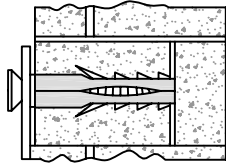
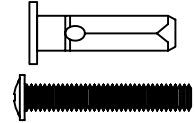

Utiliser une taille de forêt adaptée à la quincaillerie utilisée et au type de mur



Due to the wide diversity of wall or partition types, we cannot provide you with suitable attachment fixtures. To determine which attachment fixtures to use, you will need to identify the type of wall to which you will be fixing this product. Here are some examples of attachment fixtures recommended for:



BLIND WALLS

"FISCHER"
Nylon plug

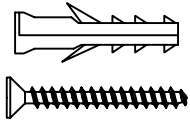

Metal
Wall plug

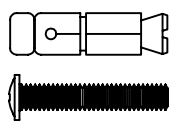

Nylon winged
Wall plug

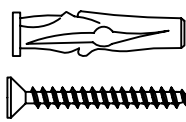

STUDED WALLS

Metal expansion
plug

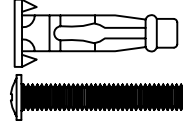

"MOLLY" plug

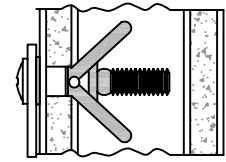
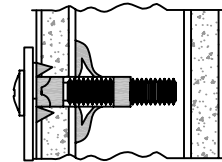
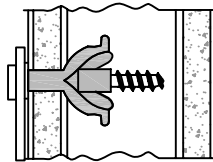
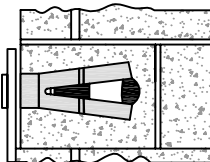
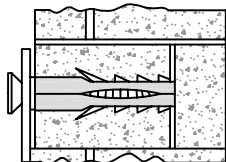
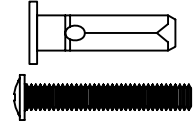

Use a drill bit that is compatible in size with the hardware used and the type of wall



Devido ao devversity largo da parede ou da divisória datlografa, nós nã o pode fornecê-lo com os dispositivos elé tricos apropriados do acessório. A determinar que dispositivos elé tricos se usar, você do acessório necessitarã identificar o tipo de parede a que você estarã reparando este produto. Estã o aqul alguns exemplos dos dispositivos elé tricos do acessório recomendados para:

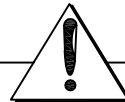

PAREDES CEGAS

"FISCHER"
Plugue de nylon

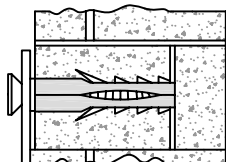
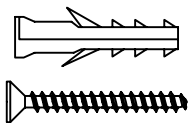

Metal
Plugue de parede

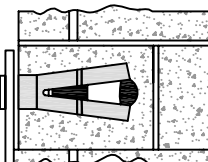
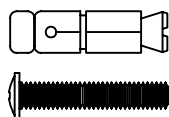

Nylon voado
Plugue de parede

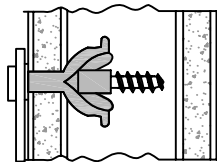
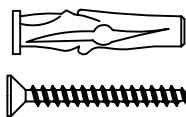

PAREDES STUDED

Expansã o do metal
plugue

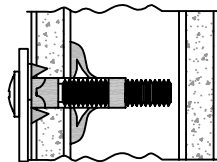
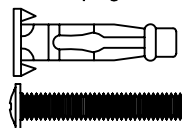

Plugue do
"MOLLY"

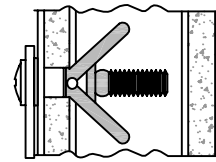
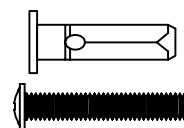

Usar um bocado de broca que seja compati vel no tamanho com a ferragem usada e o tipo de parede



Door brede devversity van de muur of van de wand typt, wij kunnen jede aangewezen montages niet leveren d'attachement. Aan bepalen van welke montages d'attachement gebruiken, u behoeftezal hebben om het soort muur te lidentificeren waaraan u zult bepalen dit product. Zlehter enkele voorbeelden van de montagesd'attachement die voor worden aanbevolen:



BLINDE MUREN

"FISCHER"
Nemen In nylon

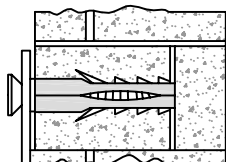
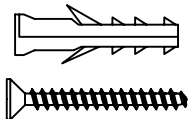

Metaal
Nemen van muur

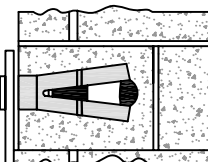
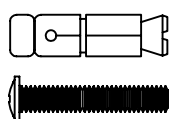

Het weggevloegen nylon s'est
Nemen van muur

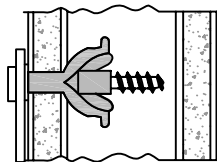
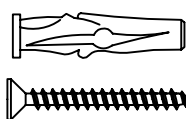

BESLAGEN MUREN

Expansie in metaal
nemen

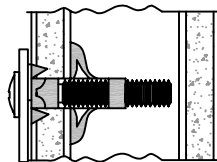
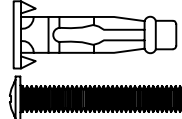

Nemen van "MOLLY"

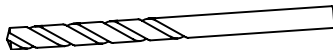
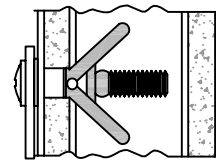
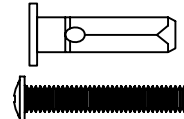

Een een beetje boor gebruiken die verenigbaar in de omvang met hetgebruikte materiaal is en het soort muur



Evitez le contact avec des matières abrasives et des objets pointus car ils peuvent endommagé la surface. Ne placez jamais des articles chauds directement sur le produit.

Avoid contact with abrasive materials and sharp objects as they can damage the surface. Please use place mats and never place hot items directly onto the product.



Evitez le contact avec des matières abrasives et des objets pointus car ils peuvent endommagé la surface. Ne placez jamais des articles chauds directement sur le produit.

Avoid contact with abrasive materials and sharp objects as they can damage the surface. Please use place mats and never place hot items directly onto the product.



Evitez le contact avec des matières abrasives et des objets pointus car ils peuvent endommagé la surface. Ne placez jamais des articles chauds directement sur le produit.

Avoid contact with abrasive materials and sharp objects as they can damage the surface. Please use place mats and never place hot items directly onto the product.



Evitez le contact avec des matières abrasives et des objets pointus car ils peuvent endommagé la surface. Ne placez jamais des articles chauds directement sur le produit.

Avoid contact with abrasive materials and sharp objects as they can damage the surface. Please use place mats and never place hot items directly onto the product.