

Схема сборки.
Наклонный стеллаж

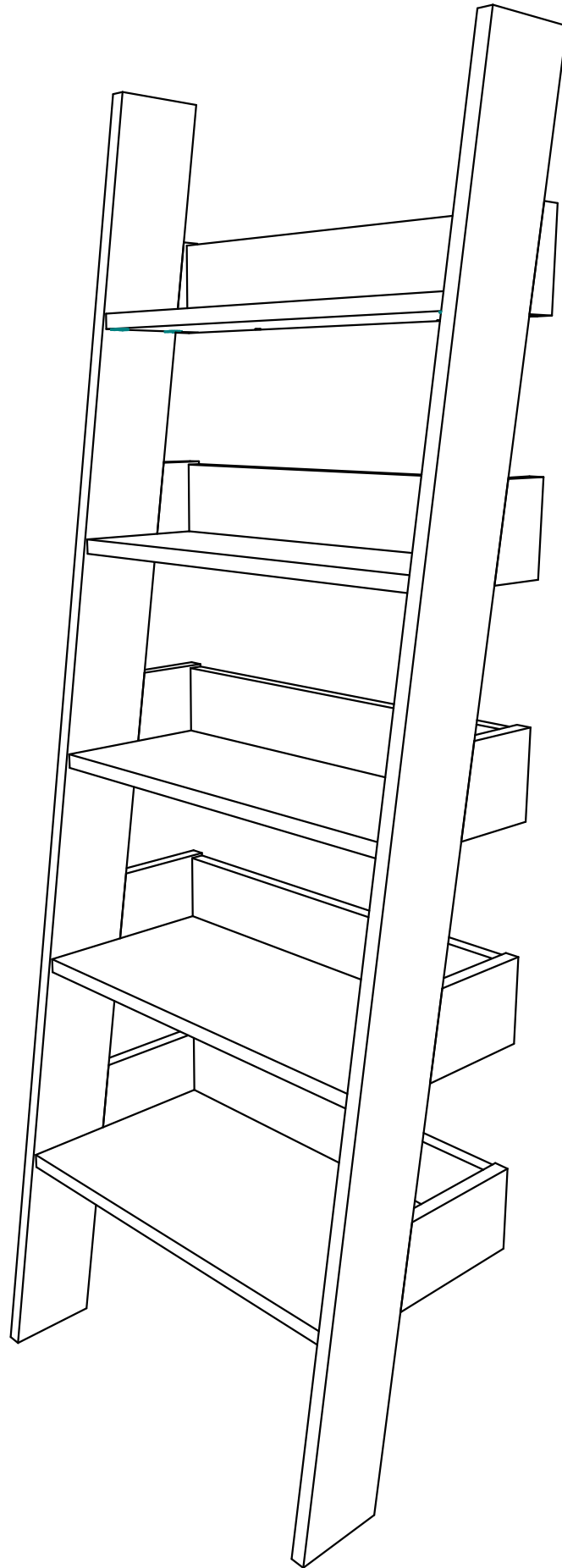

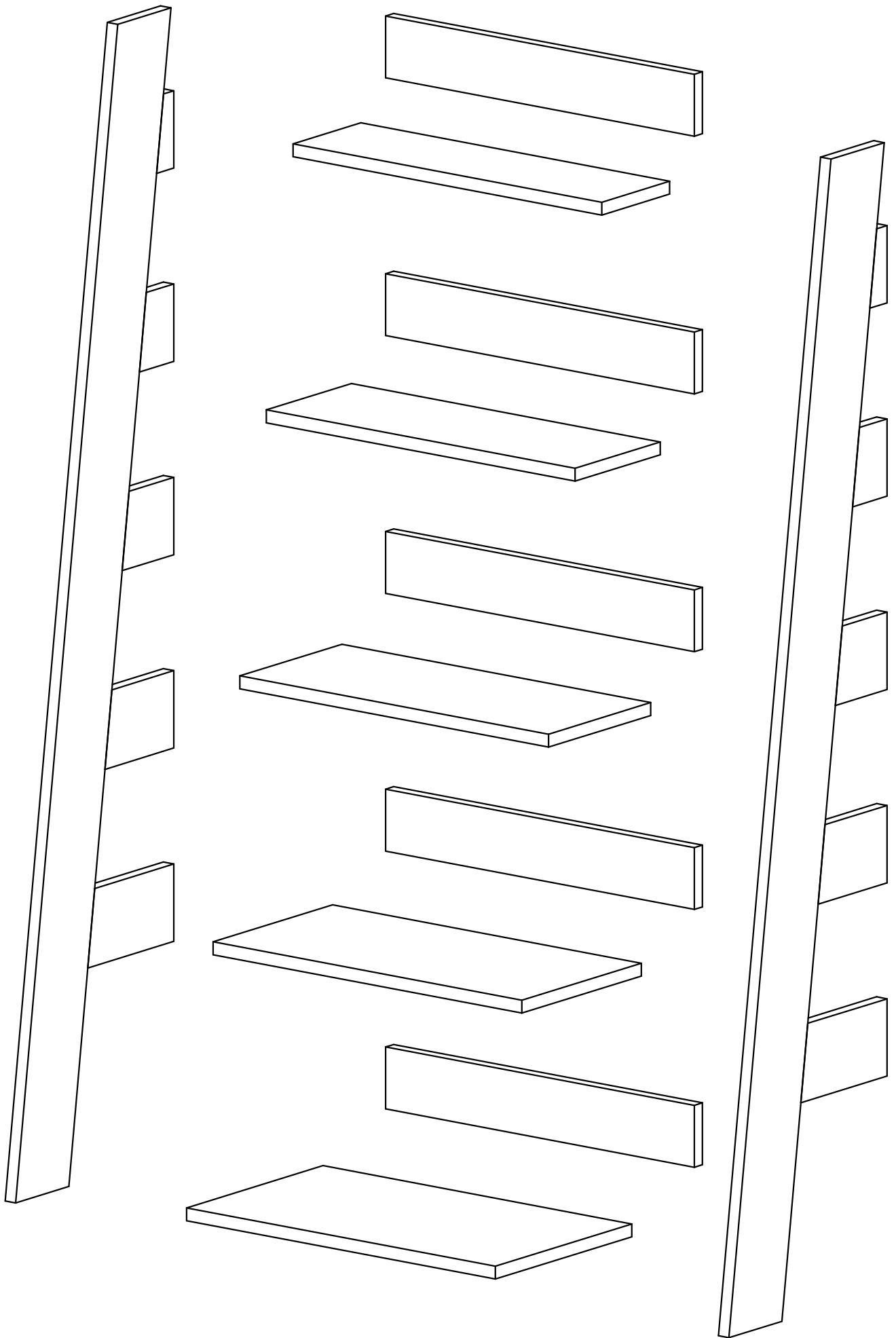

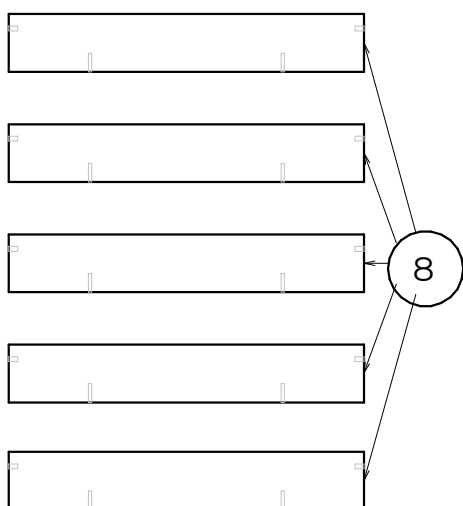
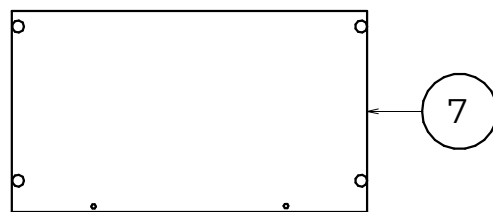
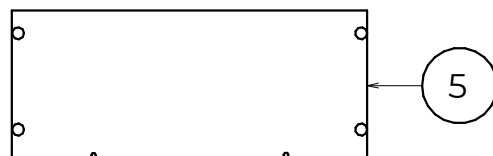
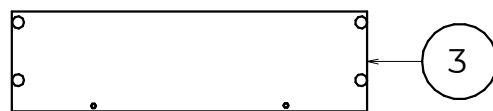
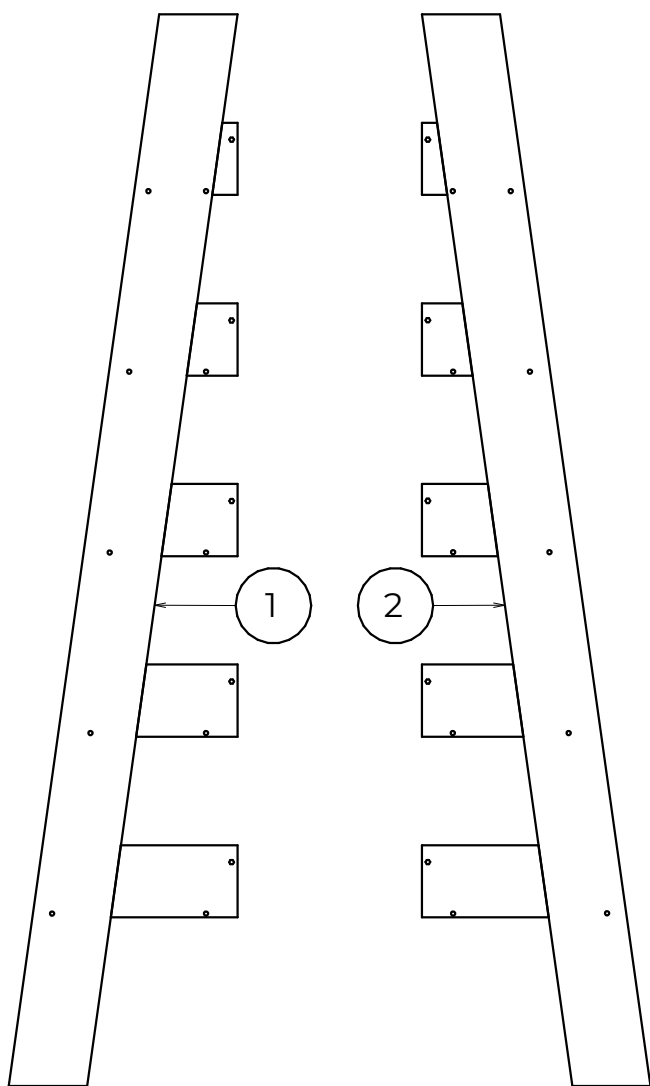

Поз.	Наименование	Длина	Ширина	Кол-во
1	Боковина левая	1780	380	1
2	Боковина правая	1780	380	1
3	Полка	590	166	1
4	Полка	590	208	1
5	Полка	590	250	1
6	Полка	590	292	1
7	Полка	590	334	1
8	Задняя стенка полки	590	96	5

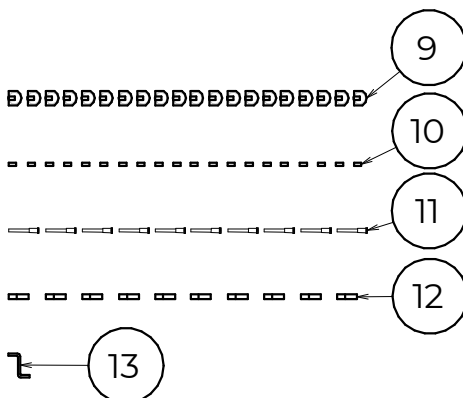

Поз.	Вид	Наименование	Кол-во
9		Эксцентрик	20
10		Шток эксцентрика	20
11		Конфирмат 7x50	10
12		Шкант 8x30	10
13		Ключ шестигранный	1

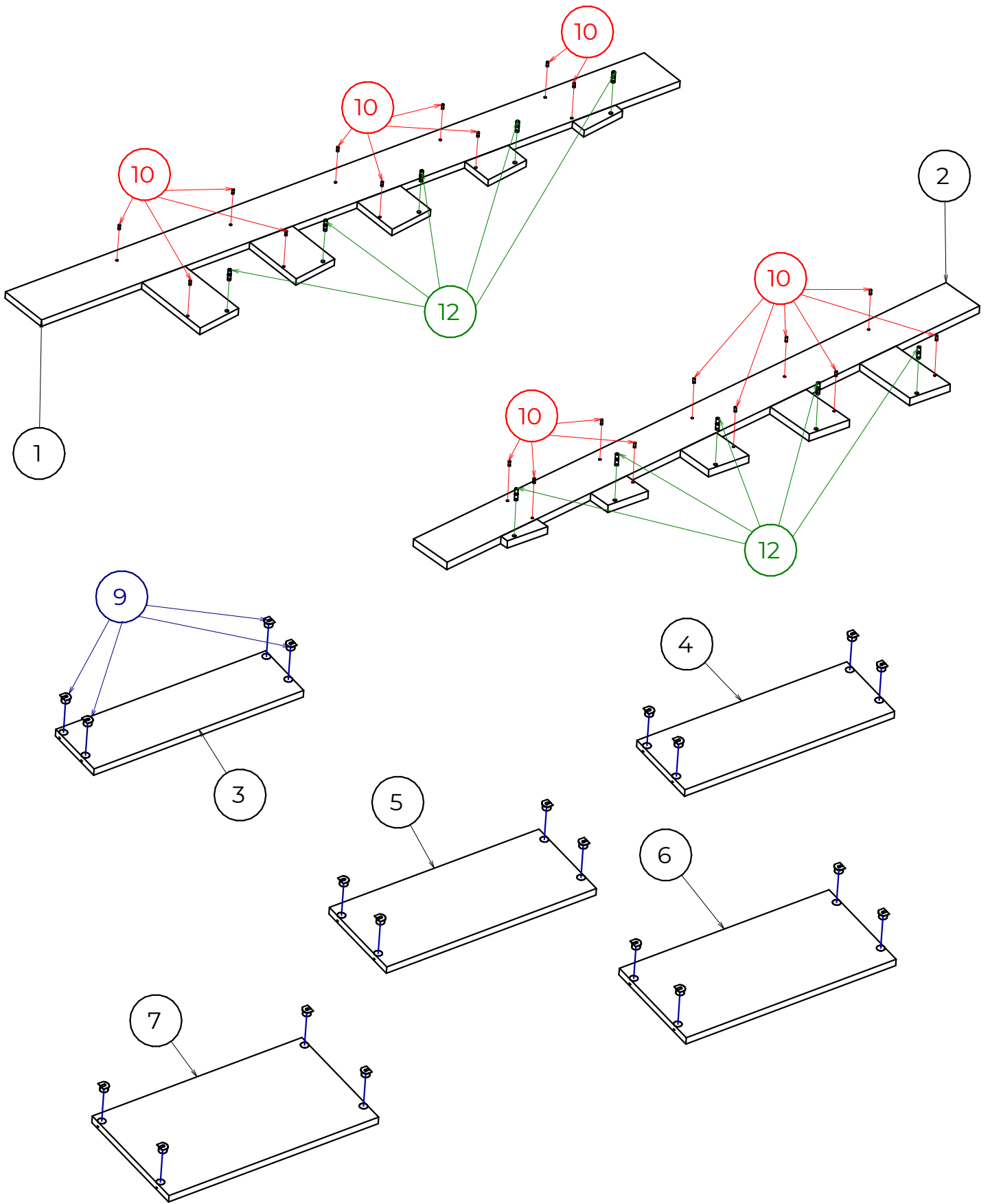

Поз.	Вид	Наименование	Кол-во
9		Эксцентрик	20
10		Шток эксцентрика	20
12		Шкант 8x30	10

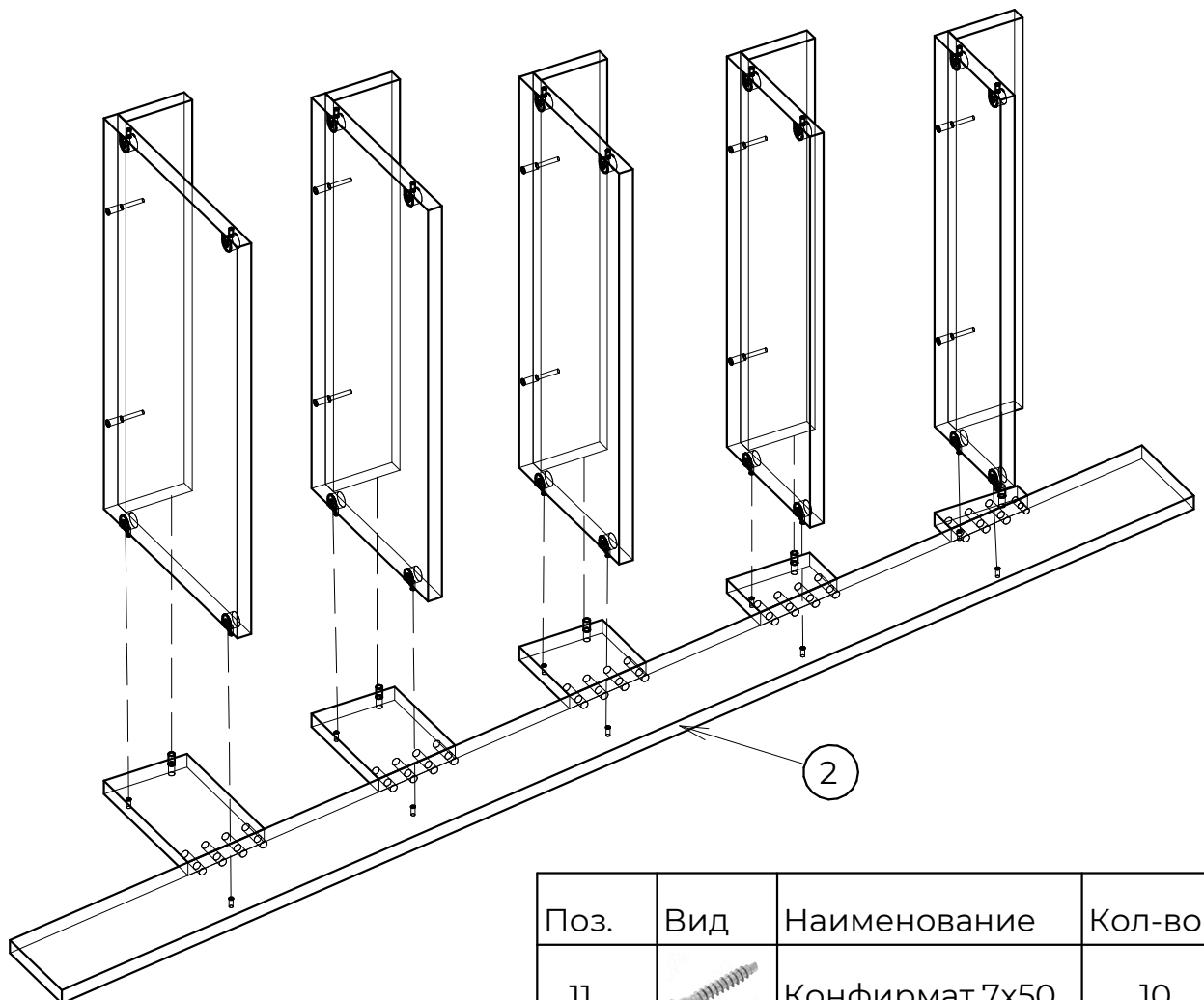
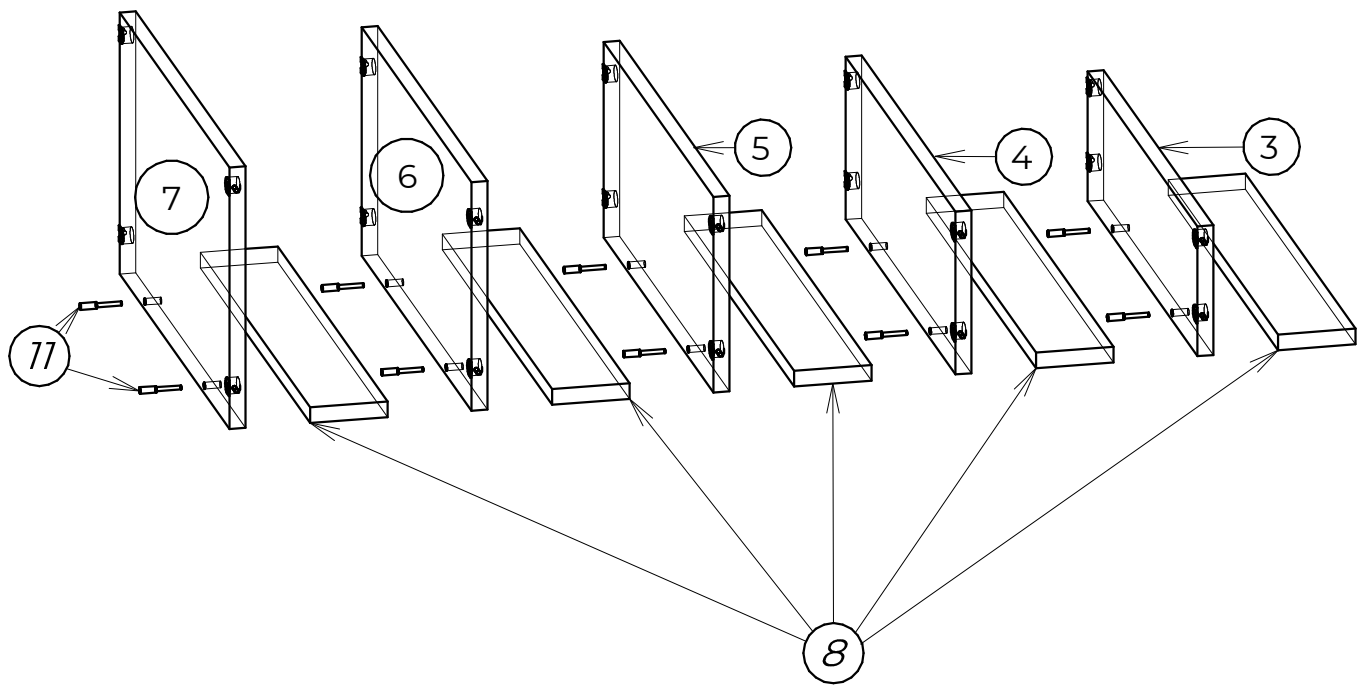

Поз.	Вид	Наименование	Кол-во
11		Конфирмат 7x50	10

