

MOYEN - MEDIUM  
MITTEL - MEDIO

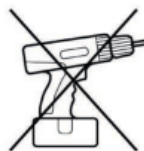

2



FR / Pour toute demande de SAV, contactez-nous via l'espace dédié « demande de SAV » accessible dans votre suivi de commandes sur notre site [www.laredoute.fr](http://www.laredoute.fr), ou nous contacter au 0 969 323 515.

UK / If you need information about your product, email [helpline@redoute.co.uk](mailto:helpline@redoute.co.uk) or call: 033 0303 0199.

CH / Wenn Sie Fragen zu Ihrem Produkt, email: [info@redoute.ch](mailto:info@redoute.ch) oder anrufen: FR/IT: 0848 848 505, DE: 0848 848 505.

BE / Si vous avez des questions sur votre produit, email: [serviceclient@redoute.be](mailto:serviceclient@redoute.be) ou appeler: 056 85 15 15 - Als u vragen over uw product, email: [klantendienst@redoute.be](mailto:klantendienst@redoute.be) of bel: 056 85 15 00.

ES / Si tiene alguna pregunta acerca de su producto, email: [contacto@laredoute.es](mailto:contacto@laredoute.es) o llamar: 902 33 00 33.

PT / Se você tiver dúvidas sobre o seu produto, email: [contacto@redoute.pt](mailto:contacto@redoute.pt) ou chamar: 707201010.

SE / Om du har frågor om din produkt, email: [service@laredoute.se](mailto:service@laredoute.se) eller ring: 033 - 48 20 00.

NW / Hvis du trenger informasjon om produktet, email: [service@laredoute.no](mailto:service@laredoute.no) eller telefon: 66-89-15-00.

IT / Se hai delle domande sul tuo articolo, ecco la mail via nuestro website.

PL / Jeśli mają Państwo pytania dotyczące produktu, prosimy pisać na numer telefonu: 32 225 28 28.

RU / Если Вам необходима дополнительная информация о товаре, свяжитесь с нами по телефонам 8 800 555 75 35 / 8 (495) 795 30 30, email: [info@laredoute.ru](mailto:info@laredoute.ru).





## Avertissement!/ Warning!

**F** A monter par un adulte. Contrôler le contenu de votre colis avant de procéder au montage. Attention: tenir les vis et petits éléments et sachets hors de portée des enfants. Ne jetez pas l'emballage, il vous sera très utile pour protéger les éléments des coups et rayures pendant le montage. Assemblez ensuite l'article en suivant l'ordre défini par la numérotation. Pour une utilisation à l'intérieur uniquement. Respecter l'ampoule recommandée. Il est impératif de couper le circuit électrique avant toute opération. Toujours débrancher la lampe et attendre 10 minutes avant toute opération. Fabriqué en Chine





**GB** To be assembled by an adult. Check the content of your parcel before assembling. Caution : Keep all screws, small parts and plastic bag out of the reach of small children. Do not throw away the packing which could be very useful to protect the panels from knocks and scratches when assembling. Assemble the article following the order of the numbers indicated. For indoor use only. To respect the bulb recommended. Cut the electric circuit before all operations. Always switch off the electricity supply and allow to cool for 10 minutes before modifications. made in China.

**Ref: GMB013**

**EAN: 3614854614534**

### NOTICE DE MONTAGE / ASSEMBLY INSTRUCTIONS

Conserver l'emballage pour information - Informations à conserver / Keep the packaging for information - Keep this information for future reference

<b>La Redoute</b>	GMB013 Made in China
Alimentation: 230V~50Hz G9 LED Max 6W	
   	
LA REDOUTE, 110 rue de blanchemaille, 59100 ROUBAIX	

1

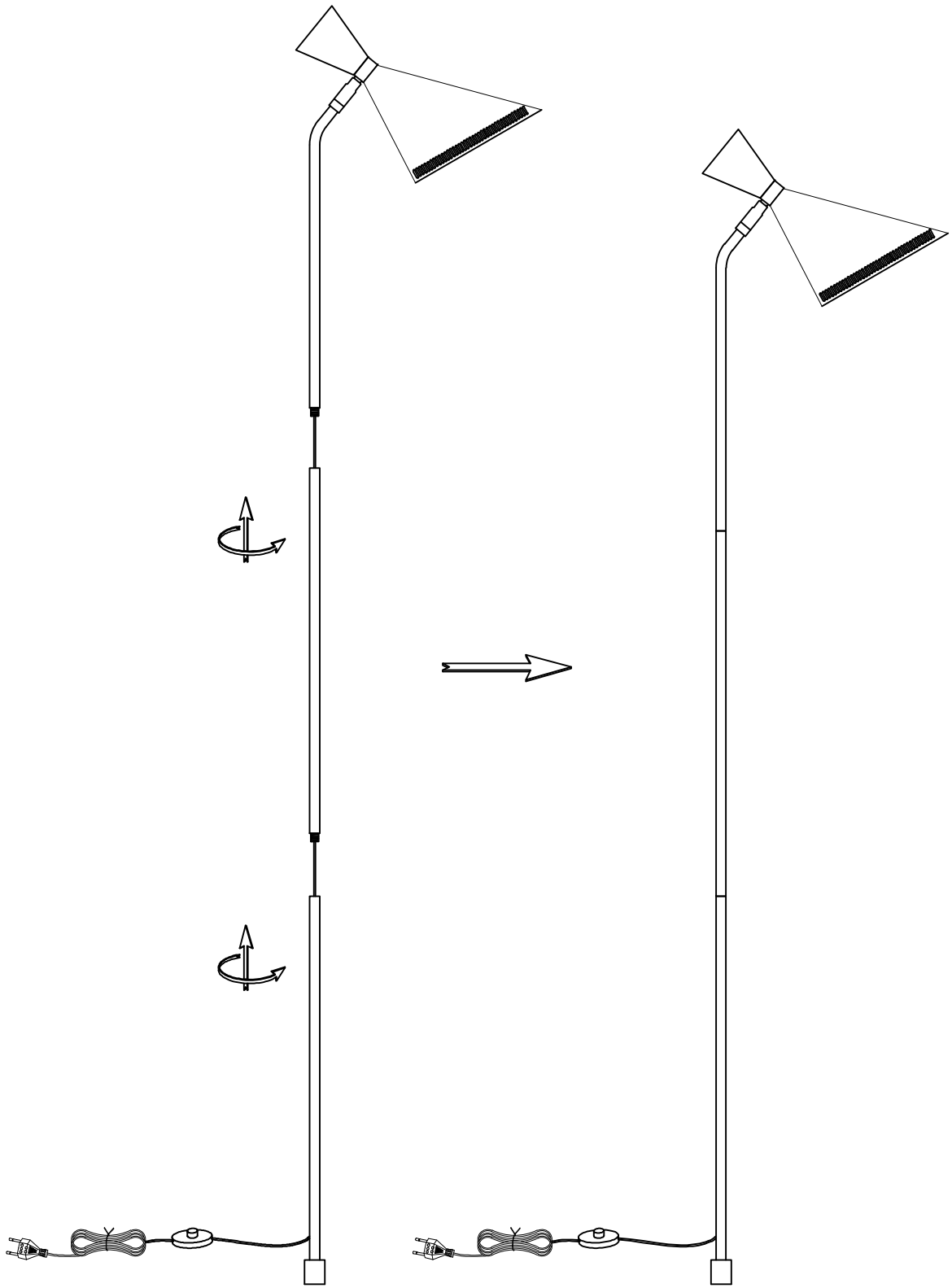

2

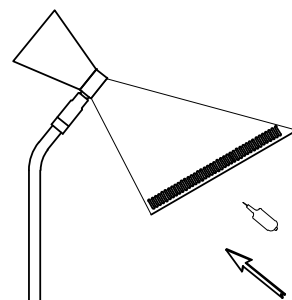
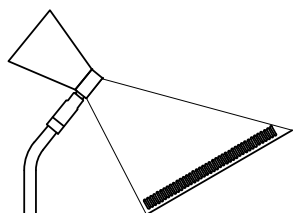

230V ~ 50Hz G9 LED Max. 6W

Bulb not included

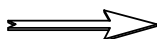

**G9 LED Max. 6W  
Energy Saving  
Not Included**

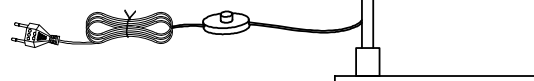
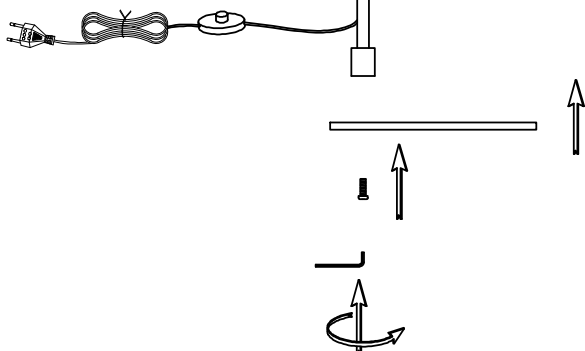

if the external flexible cable or cord of this luminaire is damaged, it shall be exclusively replaced by the manufacturer or his service agent or a similar qualified person in order to avoid a hazard

Si le cordon d'alimentation est endommagé il doit être remplacé par le fabricant, réparateur agréé ou toute personne qualifiée, afin d'éviter tout danger.

