

Ref : GNO430



10 min



Utilisation à l'intérieur uniquement  
For indoor use only



LED E27 - MAX 1x10W  
(non includes)

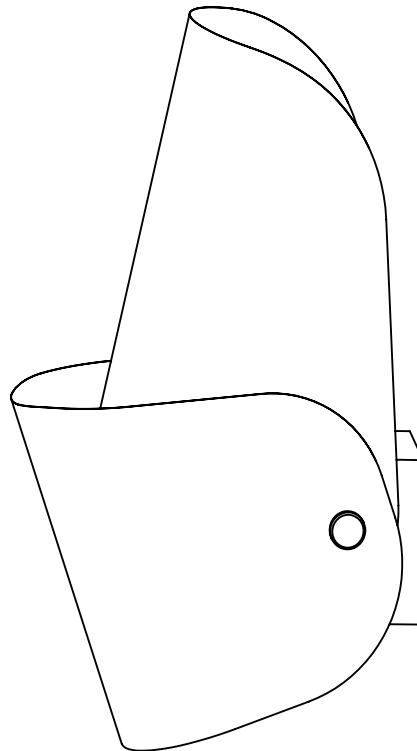

FACILE - EASY  
LEICHT - FÁCIL



1

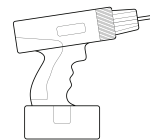

FR / Pour toute demande de SAV, contactez-nous via l'espace dédié « demande de SAV » accessible dans votre suivi de commandes sur notre site [www.laredoute.fr](http://www.laredoute.fr), ou nous contacter au 0969 323 515.

UK / If you need information about your product, email [helpline@redoute.co.uk](mailto:helpline@redoute.co.uk) or call: 033 0303 0199.

CH / Wenn Sie Fragen zu Ihrem Produkt, email: [info@redoute.ch](mailto:info@redoute.ch) oder anrufen: FR/IT: 0848 848 505, DE: 0848 848 505.

BE / Si vous avez des questions sur votre produit, email: [serviceclient@redoute.be](mailto:serviceclient@redoute.be) ou appeler: 056 85 15 15 - Als u vragen over uw product, email: [klantendienst@redoute.be](mailto:klantendienst@redoute.be) bel: 056 85 15 00.

ES / Si tiene alguna pregunta acerca de su producto, email: [contacto@laredoute.es](mailto:contacto@laredoute.es) o llamar: 902 33 00 33.

PT / Se você tiver dúvidas sobre o seu produto, email: [contacto@redoute.pt](mailto:contacto@redoute.pt) ou chamar: 707201010.

SE / Om du har frågor om din produkt, email: [service@laredoute.se](mailto:service@laredoute.se) eller ring: 033 - 48 20 00.

NW / Hvis du trenger informasjon om produktet, email: [service@laredoute.no](mailto:service@laredoute.no) eller telefon: 66-89-15-00.

IT / Se hai delle domande sul tuo articolo, ecco la mail via nostro website.

PL / Jeśli mają Państwo pytania dotyczące produktu, prosimy pisać na numer telefonu: 32 225 28 28.

RU / Если Вам необходима дополнительная информация о товаре, свяжитесь с нами по телефонам 8 800 555 75

35 / 8 (495) 795 30 30, email: [info@laredoute.ru](mailto:info@laredoute.ru).

1

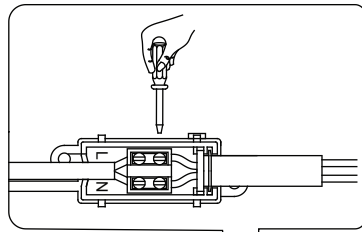
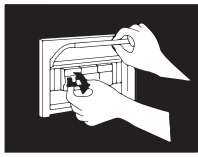

L (MARRON): PHASE  
L (BROWN): LIVE

N (BLEU): NEUTRE  
N (BLUE): NEUTRAL

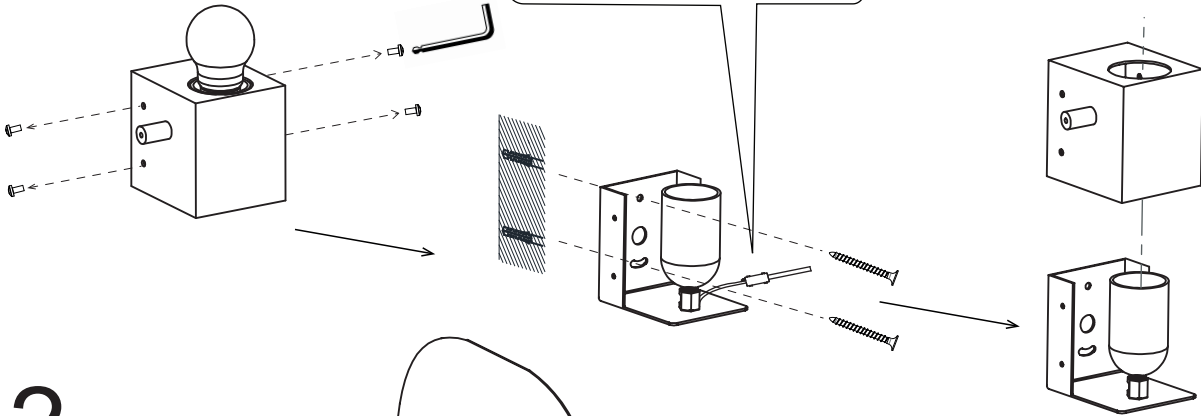

2

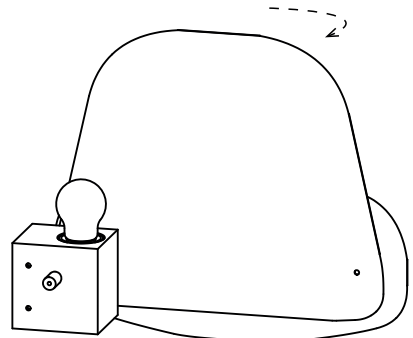
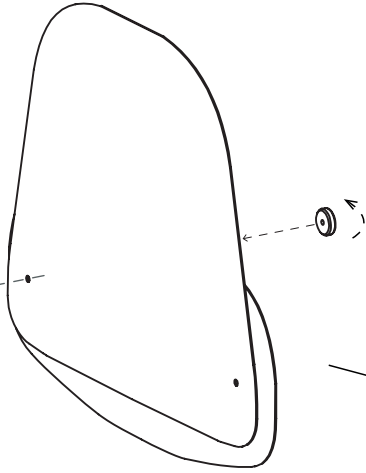
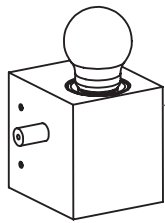

3

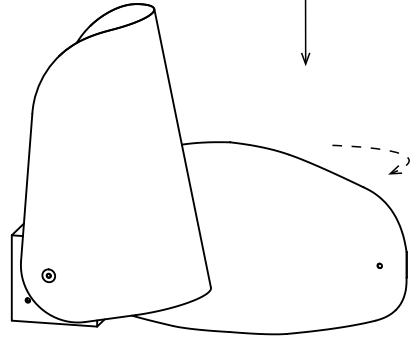
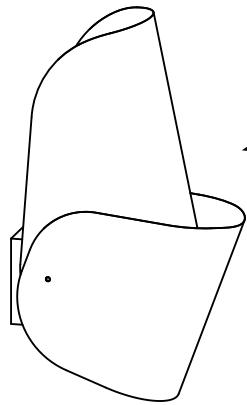
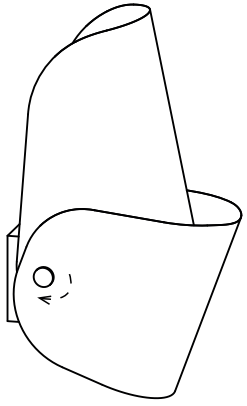

Informations à conserver / Information to be kept / Informationen aufbewahrt werden / Información que debe mantenerse / Belangrijke informatie om te bewaren / Informações importantes que é conveniente guardar / Informazioni da conservare

FR

---

Pour utilisation intérieur uniquement. Informations à conserver. Lire attentivement la notice avant la première utilisation.  
Le câble ou le cordon extérieur souple de ce luminaire ne peut pas être remplacé ; si le câble est endommagé, le luminaire doit être détruit.

UK

---

For indoor use only. Information to be kept.  
Read carefully the instruction sheet before first use.  
The flexible cable or exterior cord on this lamp cannot be replaced; if the cable is damaged, the lamp should be disposed of.

DE

---

Nur für den Innenbereich. Informationen aufbewahrt werden. Lesen Sie die Gebrauchsanweisung sorgfältig vor der Benutzung.  
Das Kabel oder das flexible Außenkabel dieser Leuchte kann nicht ersetzt werden; wenn das Kabel beschädigt ist, muss die Leuchte entsorgt werden.

ES

---

Sólo para uso en interiores. Información que debe mantenerse. Lea atentamente la hoja de instrucciones antes del primer uso.  
Ni el cable interior ni el cable exterior flexible de esta lámpara deben ser sustituidos; si el cable se daña, la lámpara de pie debe ser desechada.

NL

---

Belangrijke informatie om te bewaren.  
Aandachtig lezen voor het eerste gebruik.  
De soepele buitenkabel of het snoer van deze lamp kan niet worden vervangen; als de kabel beschadigd is, moet de lamp worden vernietigd.

PT

---

Informações importantes que é conveniente guardar.  
Ler atentalmente antes da primeira utilização.  
O cabo exterior flexível ou o fio deste candeeiro não pode ser substituído; se o cabo estiver danificado, o candeeiro tem de ser eliminado.

IT

---

Solo per uso interno. Informazioni da conservare. Leggere attentamente le istruzioni prima del primo utilizzo.  
Il cavo o il cavo esterno flessibile di questo apparecchio non possono essere sostituiti; se il cavo è danneggiato, l'apparecchio deve essere distrutto.



## Français

---

Le pictogramme de la poubelle barrée indique que le produit doit faire l'objet d'un tri. Il doit être recyclé conformément à la réglementation environnementale locale en matière de déchets. En triant les produits portant ce pictogramme, vous contribuez à réduire le volume des déchets incinérés ou enfouis, et à diminuer tout impact négatif sur la santé humaine et l'environnement.



## English

---

The crossed-out wheeled bin symbol indicates that the item should be disposed of separately from household waste. The item should be handed in for recycling in accordance with local environmental regulations for waste disposal. By separating a marked item from household waste, you will help reduce the volume of waste sent to incinerators or land-fill and minimize any potential negative impact on human health and the environment.



## Deutsch

---

Das Symbol mit der durchgestrichenen Abfalltonne bedeutet, dass das Produkt getrennt vom Haushaltsabfall entsorgt werden muss. Das Produkt muss gem. der örtlichen Entsorgungsvorschriften der Wiederverwertung zugeführt werden. Durch separate Entsorgung des Produkts trägst du zur Minderung des Verbrennungs- oder Deponieabfalls bei und reduzierst eventuelle negative Einwirkungen auf die menschliche Gesundheit und die Umwelt.



## Nederlands

---

Het symbool met de doorgestreepte vuilnisbak op wieltjes geeft aan dat het product gescheiden van het huishoudelijk afval moet worden aangeboden. Het product moet worden ingeleverd voor recycling in overeenstemming met de plaatselijke milieuvoorschriften voor afvalverwerking. Door producten met dit symbool te scheiden van het huishoudelijk afval, help je de hoeveelheid afval naar verbrandingsovens of stortplaatsen te verminderen en eventuele negatieve invloeden op de volksgezondheid en het milieu te minimaliseren.



## Español

---

La imagen del cubo de basura tachado indica que el producto no debe formar parte de los residuos habituales del hogar. Se debe reciclar según la normativa local medioambiental de eliminación de residuos. Cuando separas los productos que llevan esta imagen, contribuyes a reducir el volumen de residuos que se incineran o se envían a vertederos y minimizas el impacto negativo sobre la salud y el medio ambiente.



## Português

---

O símbolo do caixote do lixo com o sinal de proibição indica que esse artigo deve ser separado dos resíduos domésticos convencionais. Deve ser entregue para reciclagem de acordo com as regulamentações ambientais locais para tratamento de resíduos. Ao separar um artigo assinalado dos resíduos domésticos, ajuda a reduzir o volume de resíduos enviados para os incineradores ou aterros, minimizando o potencial impacto negativo na saúde pública e no ambiente.



## Italiano

---

Il simbolo del cassonetto barrato indica che il prodotto non può essere eliminato con i comuni rifiuti domestici. Il prodotto dev'essere riciclato nel rispetto delle norme ambientali locali per lo smaltimento dei rifiuti. Separando un prodotto contrassegnato da questo simbolo dai rifiuti domestici, aiuterai a ridurre il volume dei rifiuti destinati agli inceneritori o alle discariche, minimizzando così qualsiasi possibile impatto negativo sulla salute umana e sull'ambiente.