

GUIDE DE MONTAGE

CANAPÉ MODULABLE GEORGES



GABRIELLE
PARIS

NOTICE DE MONTAGE

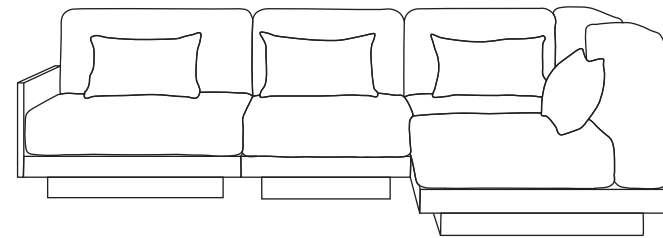

Ceci est un exemple de combinaison possible réalisé avec les modules du canapé Georges. Cette notice est commune aux différentes combinaisons. Si vous achetez les modules seuls et non une des combinaisons proposées, une pièce de connexion est à acheter séparément.



Temps de montage : varie selon le canapé choisi.

LA PIÈCE DE CONNEXION

Afin d'assembler vos modules, une pièce de connexion est nécessaire.

- 1 SOULEVEZ LA STRUCTURE ET INSÉREZ LA PIÈCE DE CONNEXION DANS LES ENCOCHES

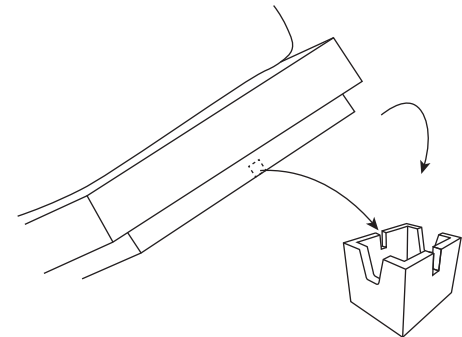

vue du dessus

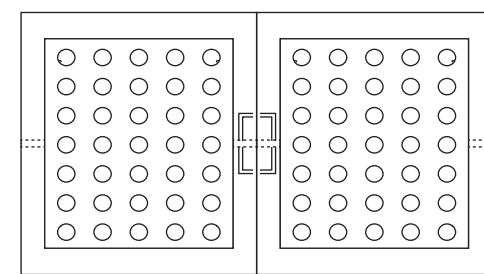

METTRE À NIVEAU LE CANAPÉ

- 1 ENLEVEZ LA PLANCHE D'ASSISE

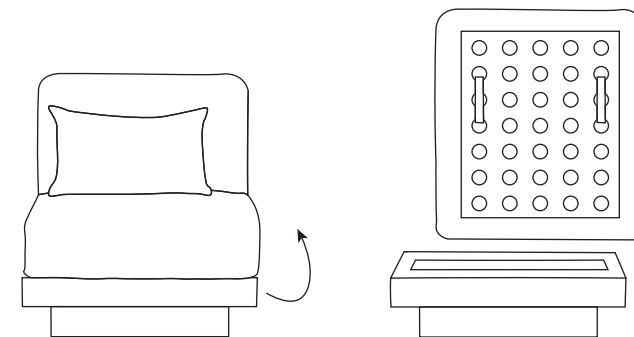

- 2 VISSEZ OU DÉVISSEZ LA MOLETTE POUR METTRE À NIVEAU ET CORRIGER LES IMPERFECTIONS DE VOTRE SOL

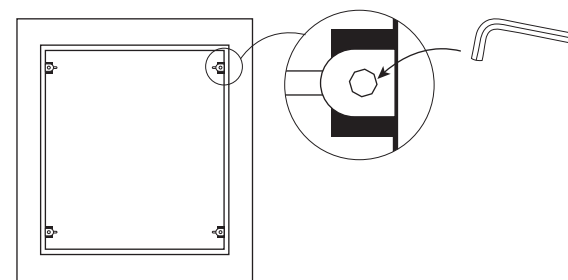

POUR DÉTACHER L'ASSISE

- 1 SOULEVEZ LA PLANCHE D'ASSISE

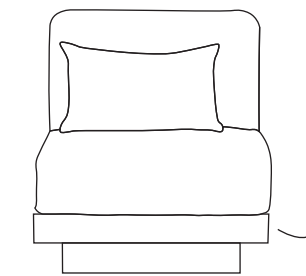

- 2 DÉTACHEZ LES SANGLES

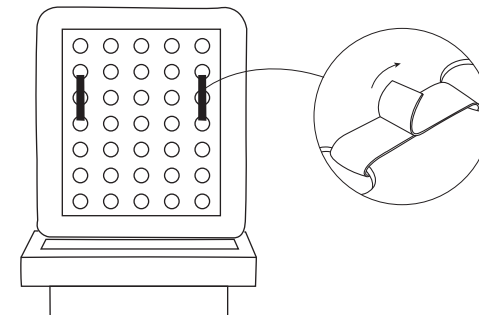

POUR METTRE LES SANGLES

Les assises sont accrochées par le dessous. Pour les remettre, attachez les sangles comme indiquées ci-dessous.

pour le pouf

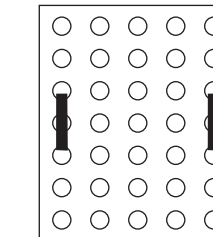

pour le fauteuil d'angle et accoudoir XL

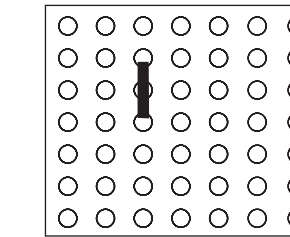

pour la chauffeuse 70

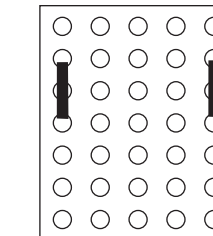

pour la chauffeuse 90 et l'accoudoir

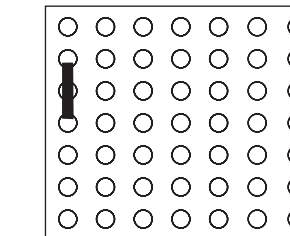

contact@gabrielle-paris.com

GABRIELLE
PARIS

ASSEMBLY INSTRUCTION

GEORGES MODULAR SOFA



GABRIELLE
PARIS

ASSEMBLY INSTRUCTION

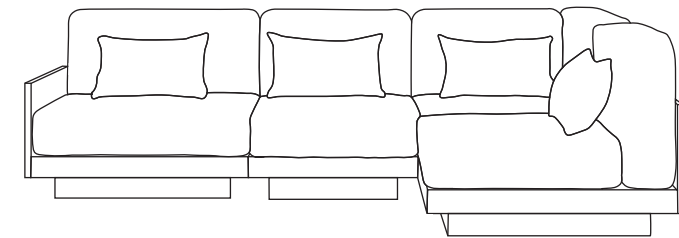

This is an example of a possible combination with modules of the Georges sofa. These instructions are common to all combinations. If you buy the modules alone and not one of the combinations proposed, a connecting piece must be purchased separately.



Assembly time: different according to the option of sofa.

THE CONNECTING PIECE

To assemble your modules, you need a connecting piece.

- 1 LIFT THE STRUCTURE AND INSERT THE CONNECTING PIECE INTO THE NOTCHES

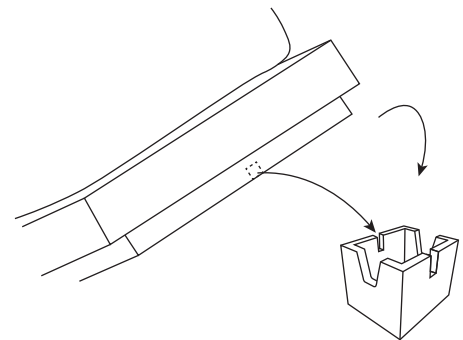

top view

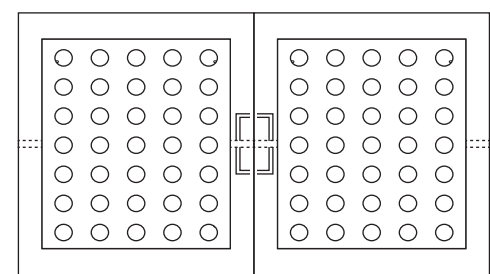

LEVELING THE SOFA

- 1 REMOVE THE SEAT BOARD

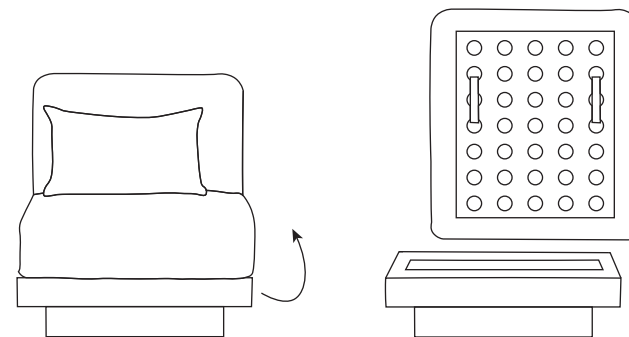

- 2 SCREW OR UNSCREW THE KNOB TO LEVEL AND CORRECT IMPERFECTIONS IN YOUR FLOOR

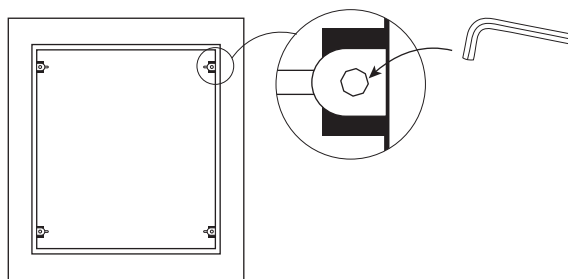

TO REMOVE THE SEAT

- 1 LIFT THE SEAT BOARD

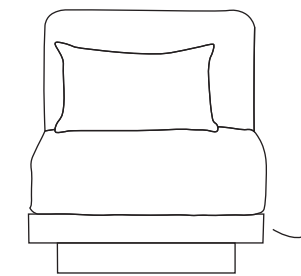

- 2 RELEASE THE STRAPS

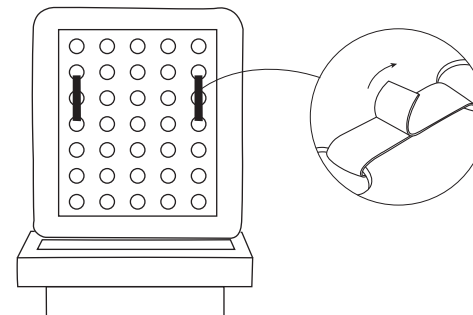

TO FIT THE STRAPS

The seats are hooked in from below. To replace them attach the straps as shown below.

for the ottoman

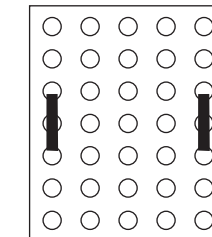

for the corner module and the armrest module XL

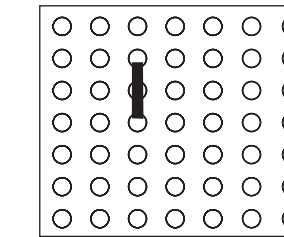

for the low chair 70

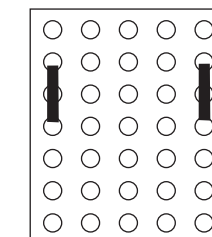

for the low chair 90 and the armrest module

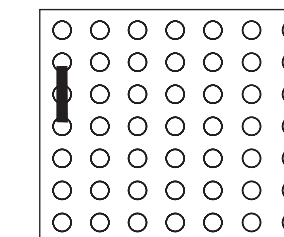

contact@gabrielle-paris.com

GABRIELLE
PARIS