

La Redoute

♦ INTERIEURS ♦

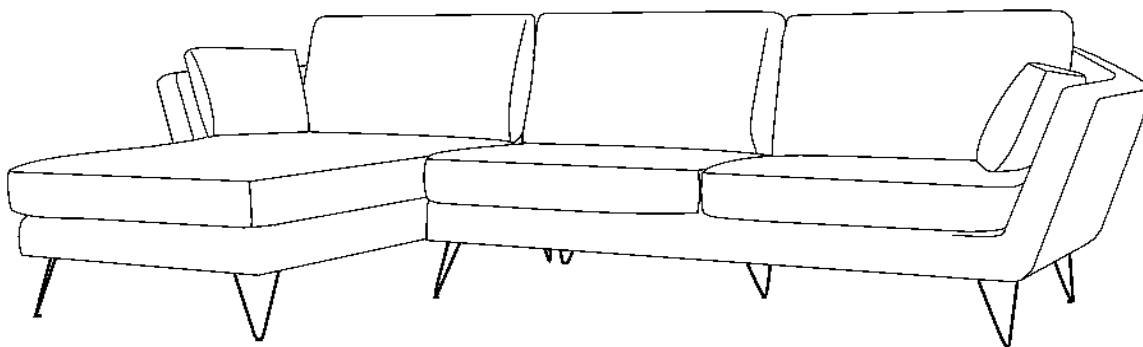

MOYEN - MEDIUM
MITTEL - MEDIO

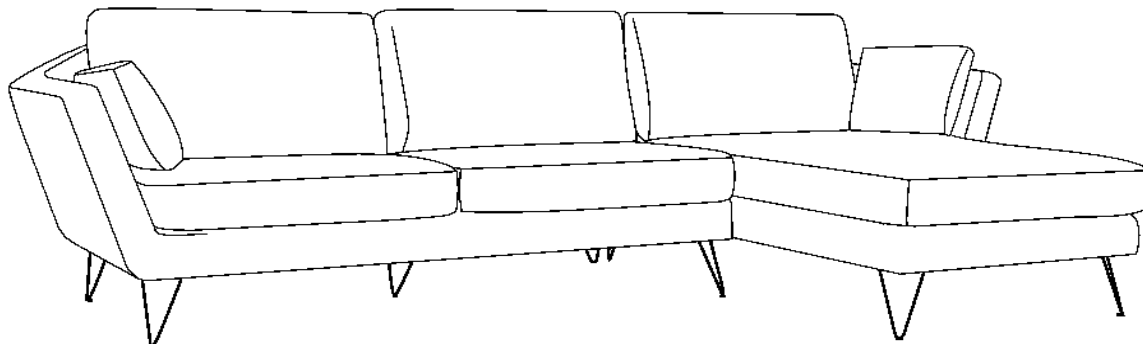
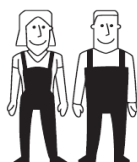

2

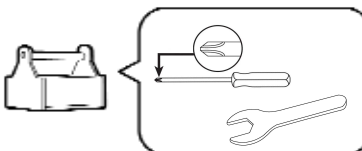

FR / Si vous avez des questions sur votre produit, email: sitegsm@redoute.fr ou appeler au: 0 969 323 515.

UK / If you need information about your product, email helpline@redoute.co.uk or call: 033 0303 0199.

CH / Wenn Sie Fragen zu Ihrem Produkt, email: info@redoute.ch oder anrufen: FR/IT: 0848 848 505, DE: 0848 848 505.

BE / Si vous avez des questions sur votre produit, email: serviceclient@redoute.be ou appeler: 056 85 15 15 - Als u vragen over uw product, email: klantendienst@redoute.be of bel: 056 85 15 00.

ES / Si tiene alguna pregunta acerca de su producto, email: contacto@laredoute.es o llamar: 902 33 00 33.

PT / Se você tiver dúvidas sobre o seu produto, email: contacto@redoute.pt ou chamar: 707201010.

SE / Om du har frågor om din produkt, email: service@laredoute.se eller ring: 033 - 48 20 00.

NW / Hvis du trenger informasjon om produktet, email: service@laredoute.no eller telefon: 66-89-15-00.

IT / Se hai delle domande sul tuo articolo, ecco la mail via nuestro website.

PL / Jeśli mają Państwo pytania dotyczące produktu, prosimy pisać na numer telefonu: 32 225 28 28.

RU / Если Вам необходима дополнительная информация о товаре, свяжитесь с нами по телефонам 8 800 555 75 35 / 8 (495) 795 30 30, email: info@laredoute.ru.

La Redoute

♦ INTERIEURS ♦

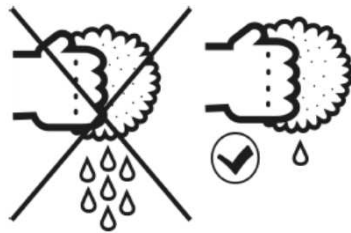
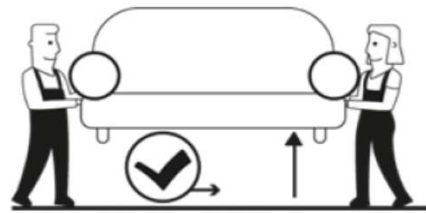
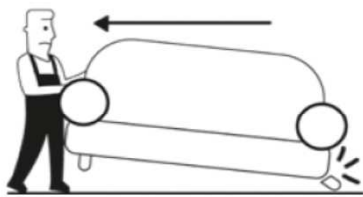
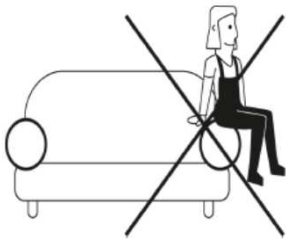
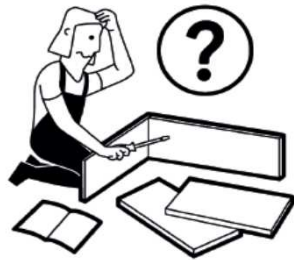
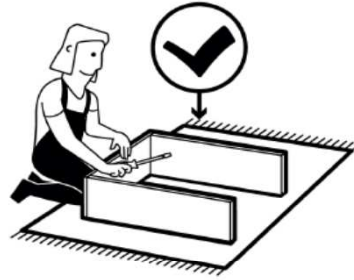
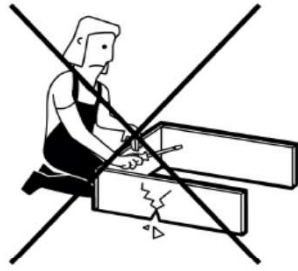

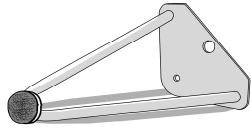
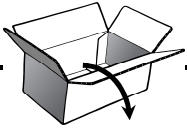
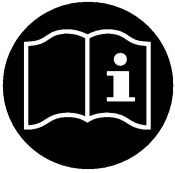

Pieds

A x10



Vis

B x10

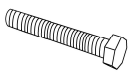

Vis

C x10

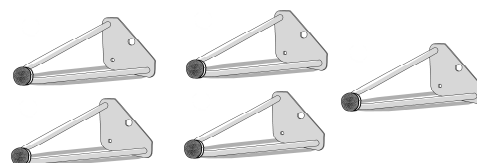
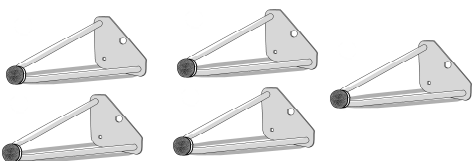
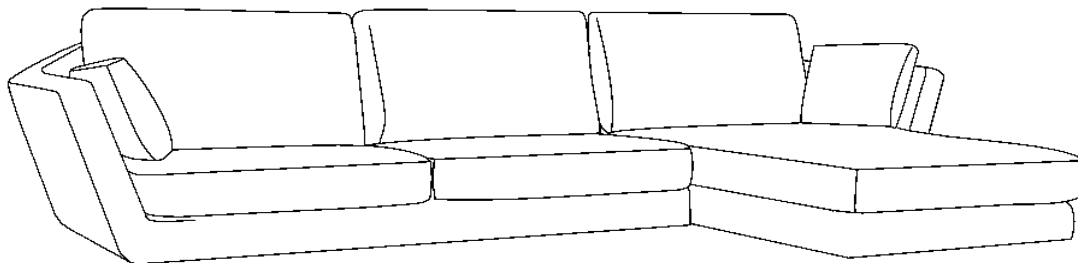
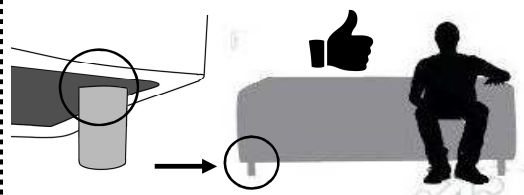
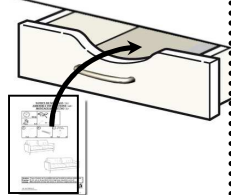
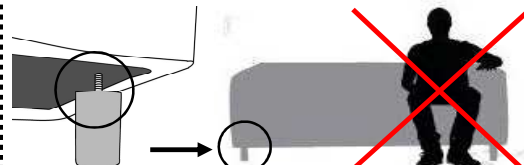
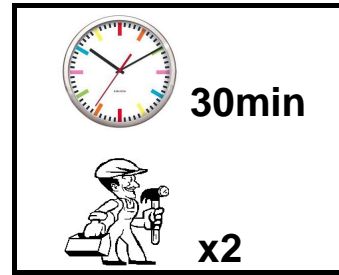
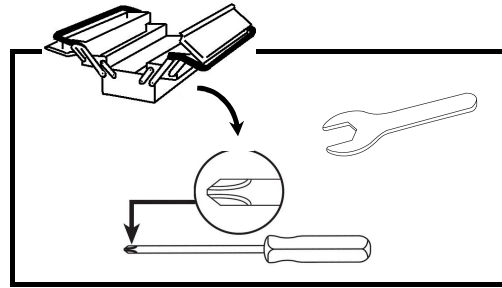

ref notice :

NOTRETREAF

1.

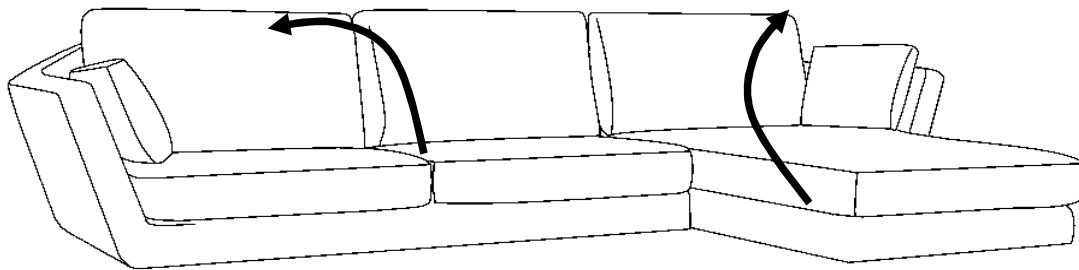

2.

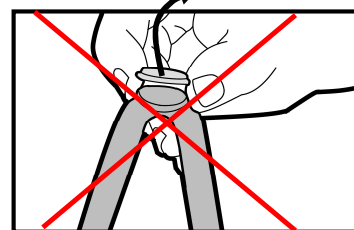
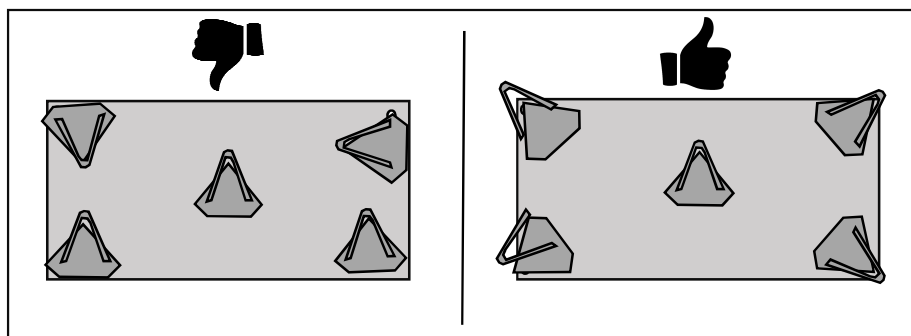
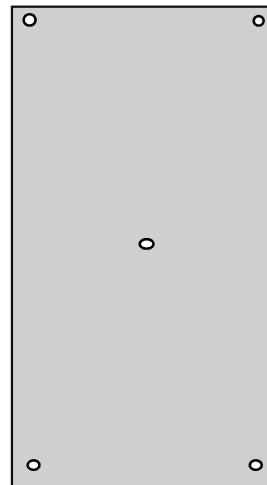
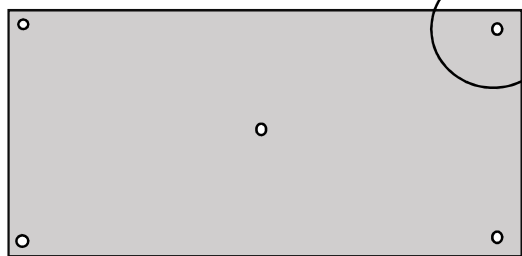
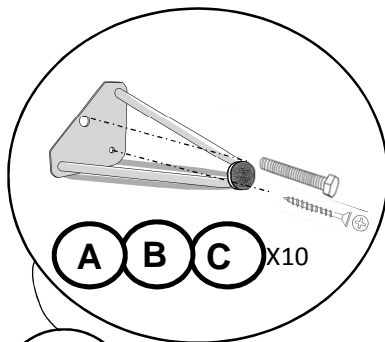

3.

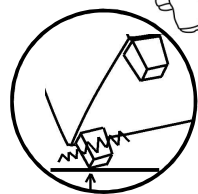
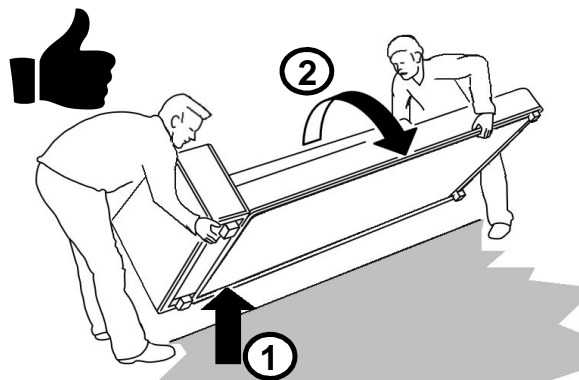
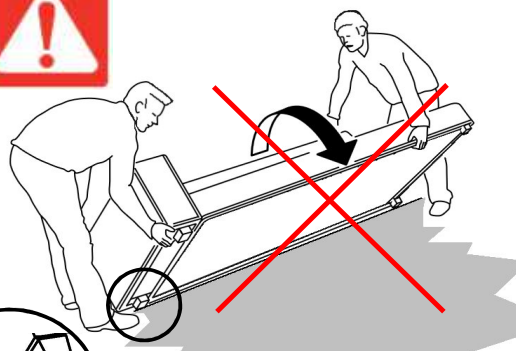

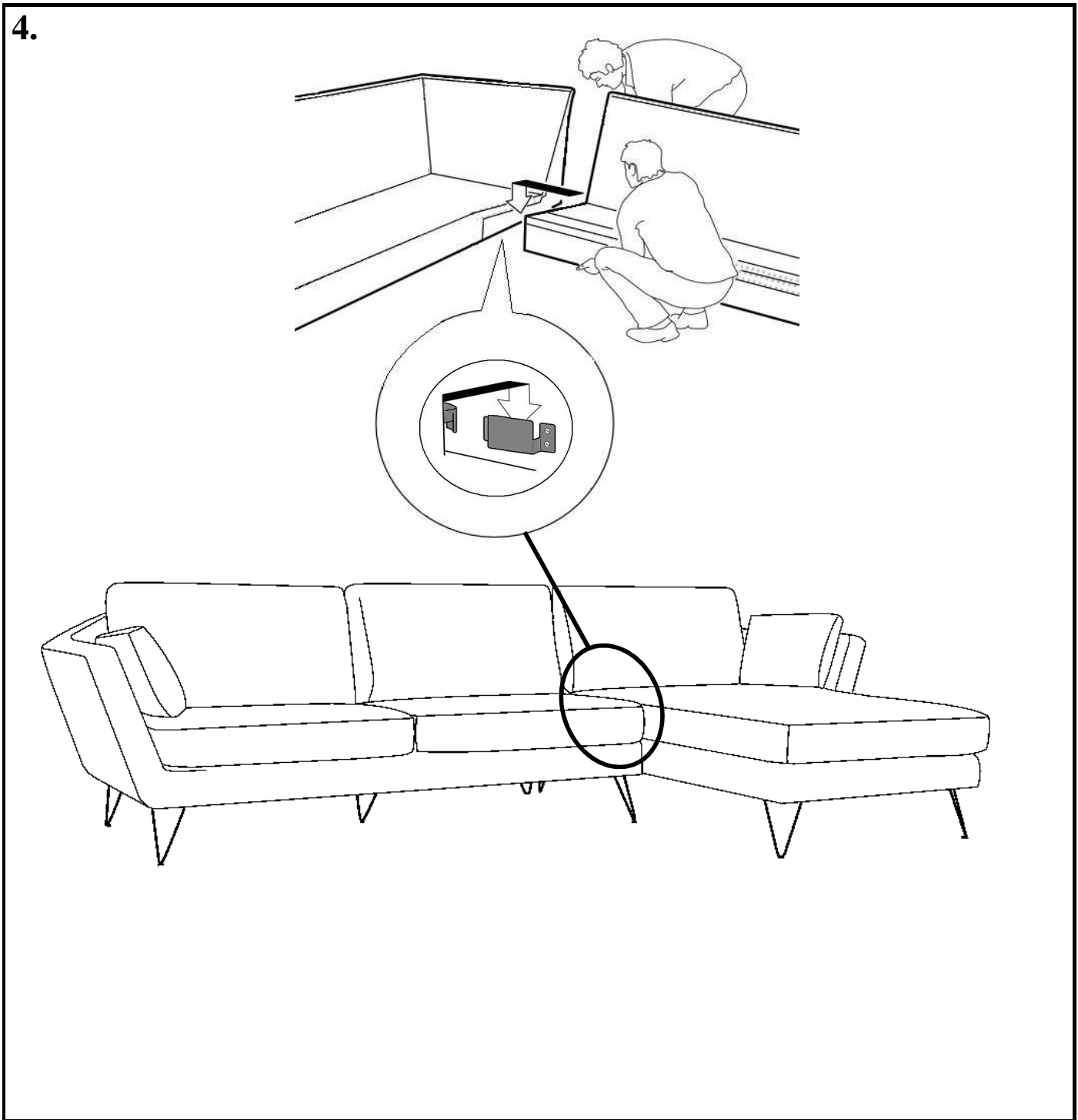
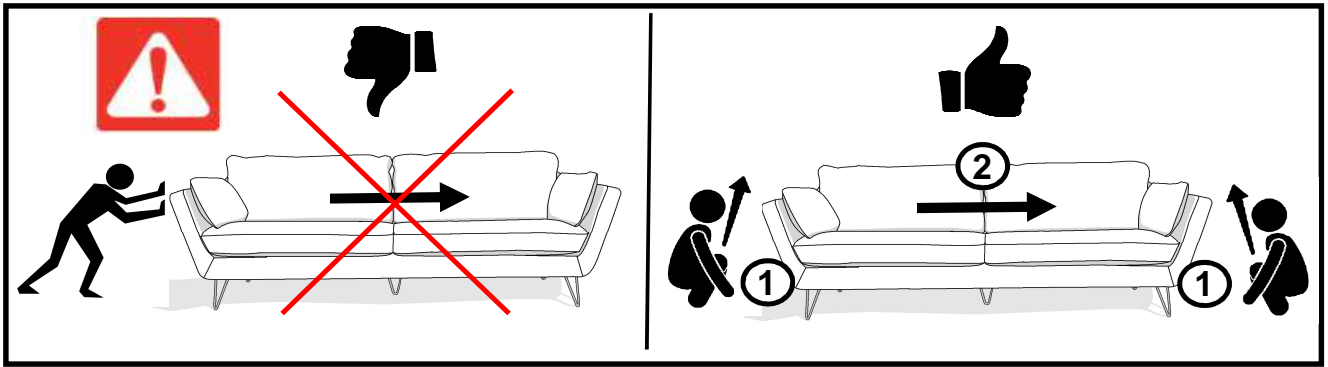

ref notice :

NOTRETREAF