

# La Redoute

♦ INTERIEURS ♦

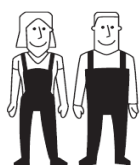

MOYEN - MEDIUM  
MITTEL - MEDIO



2

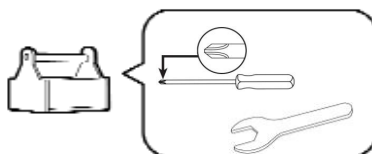

FR / Pour toute demande de SAV, contactez-nous via l'espace dédié « demande de SAV » accessible dans votre suivi de commandes sur notre site [www.laredoute.fr](http://www.laredoute.fr), ou nous contacter au 0 969 323 515.

UK / If you need information about your product, email [helpline@laredoute.co.uk](mailto:helpline@laredoute.co.uk) or call: 033 0303 0199.

CH / Wenn Sie Fragen zu Ihrem Produkt, email: [info@laredoute.ch](mailto:info@laredoute.ch) oder anrufen: FR/IT: 0848 848 505, DE: 0848 848 505.

BE / Si vous avez des questions sur votre produit, email: [serviceclient@laredoute.be](mailto:serviceclient@laredoute.be) ou appeler: 056 85 15 15 - Als u vragen over uw product, email: [klantendienst@laredoute.be](mailto:klantendienst@laredoute.be) of bel: 056 85 15 00.

ES / Si tiene alguna pregunta acerca de su producto, email: [contacto@laredoute.es](mailto:contacto@laredoute.es) o llamar: 902 33 00 33

PT / Se você tiver dúvidas sobre o seu produto, email: [contacto@laredoute.pt](mailto:contacto@laredoute.pt) ou chamar: 707201010.

SE / Om du har frågor om din produkt, email: [service@laredoute.se](mailto:service@laredoute.se) eller ring: 033 - 48 20 00.

NW / Hvis du trenger informasjon om produktet, email: [service@laredoute.no](mailto:service@laredoute.no) eller telefon: 66-89-15-00.

IT / Se hai delle domande sul tuo articolo, ecco la mail via nuestro website.

PL / Jeśli mają Państwo pytania dotyczące produktu, prosimy pisać na numer telefonu: 32 225 28 28.

RU / Если Вам необходима дополнительная информация о товаре, свяжитесь с нами по телефонам 8 800 555 75 35 / 8 (495) 795 30 30, email: [info@laredoute.ru](mailto:info@laredoute.ru).

# La Redoute

♦ INTERIEURS ♦

---

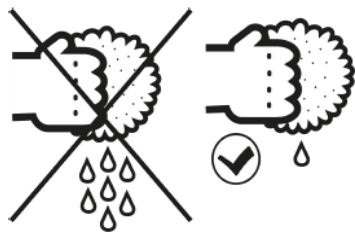
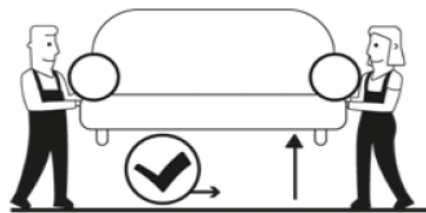
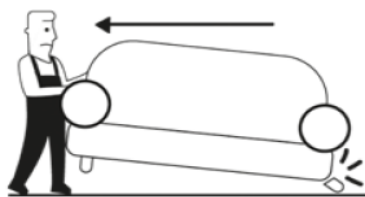
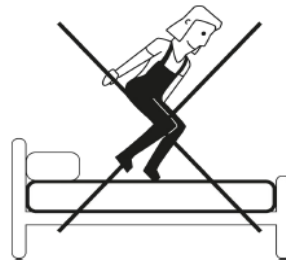
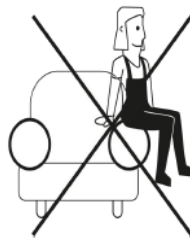
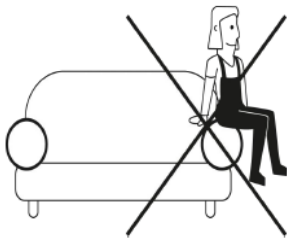
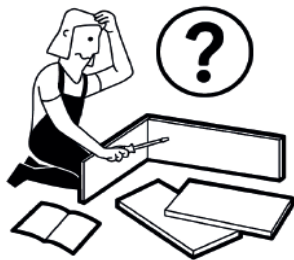
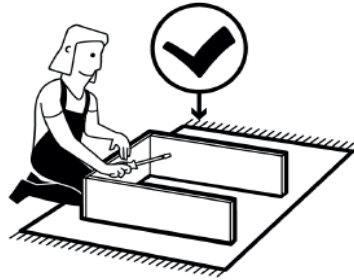
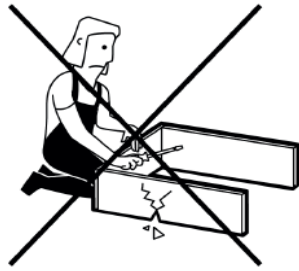

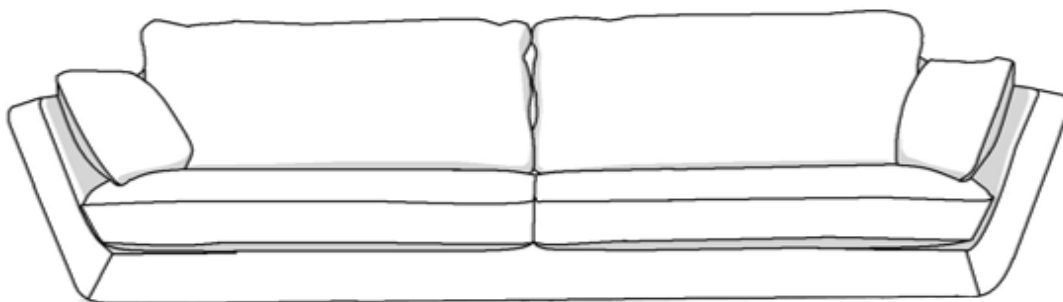
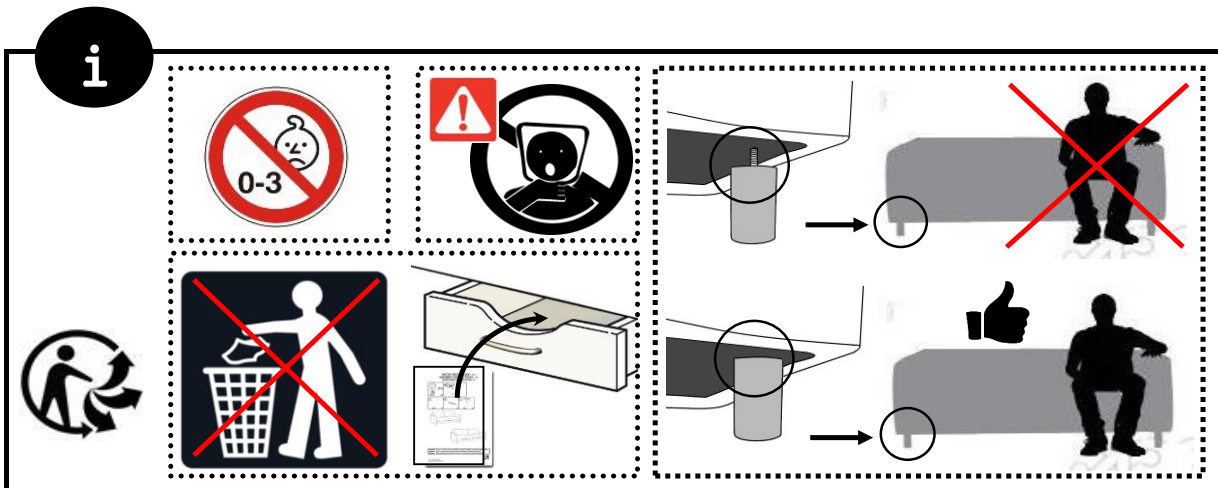
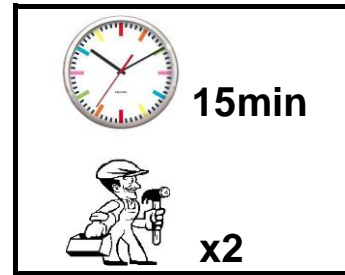
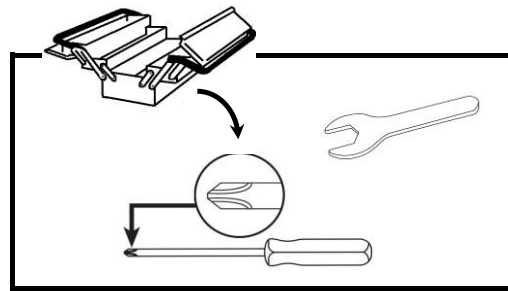
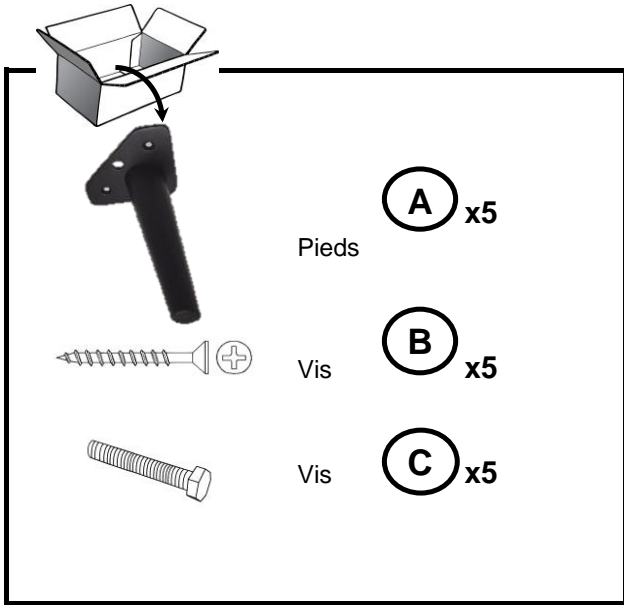

ref notice :

NOTETERNCF

1.

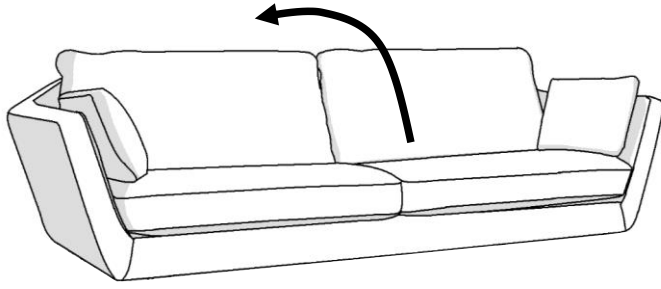

2.

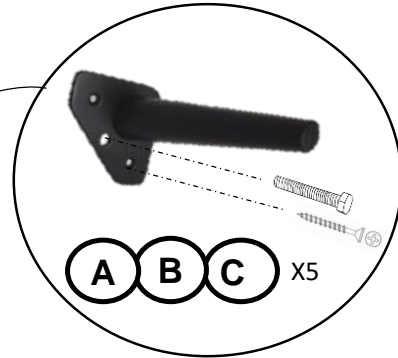
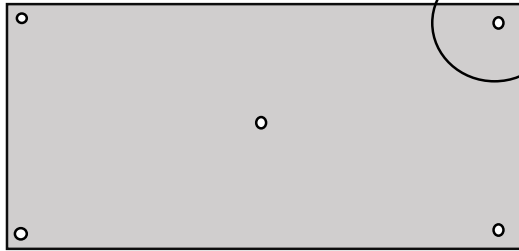

**orientation du pied**

