

**MOYEN - MEDIUM  
MITTEL - MEDIO**

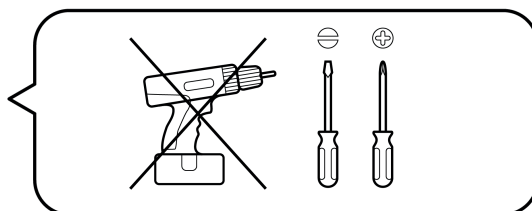
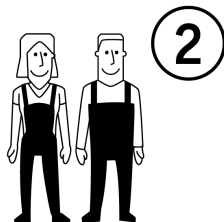

**FR /** Si vous avez des questions sur votre produit, email: [sitegsm@redoute.fr](mailto:sitegsm@redoute.fr) ou appeler au: 0 969 323 515.

**UK /** If you need information about your product, email [helpline@redoute.co.uk](mailto:helpline@redoute.co.uk) or call: 033 0303 0199.

**CH /** Wenn Sie Fragen zu Ihrem Produkt, email: [info@redoute.ch](mailto:info@redoute.ch) oder anrufen: FR/IT: 0848 848 505, DE: 0848 848 505.

**BE /** Si vous avez des questions sur votre produit, email: [serviceclient@redoute.be](mailto:serviceclient@redoute.be) ou appeler: 056 85 15 15 - Als u vragen over uw product, email: [klantendienst@redoute.be](mailto:klantendienst@redoute.be) of bel: 056 85 15 00.

**ES /** Si tiene alguna pregunta acerca de su producto, email: [contacto@laredoute.es](mailto:contacto@laredoute.es) o llamar: 902 33 00 33.

**PT /** Se você tiver dúvidas sobre o seu produto, email: [contacto@redoute.pt](mailto:contacto@redoute.pt) ou chamar: 707201010.

**SE /** Om du har frågor om din produkt, email: [service@laredoute.se](mailto:service@laredoute.se) eller ring: 033 - 48 20 00.

**NW /** Hvis du trenger informasjon om produktet, email: [service@laredoute.no](mailto:service@laredoute.no) eller telefon: 66-89-15-00.

**IT /** Se hai delle domande sul tuo articolo, ecco la mail via nostro website.

**PL /** Jeśli mają Państwo pytania dotyczące produktu, prosimy pisać na numer telefonu: 32 225 28 28.

**RU /** Если Вам необходима дополнительная информация о товаре, свяжитесь с нами по телефонам 8 800 555 75 35 / 8 (495) 795 30 30, email: [info@laredoute.ru](mailto:info@laredoute.ru).

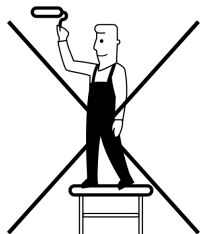
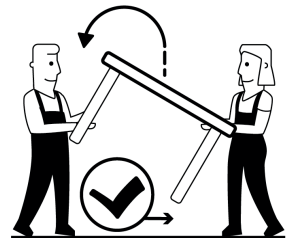
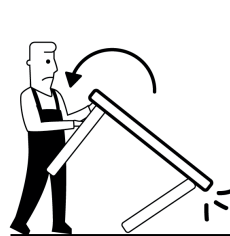
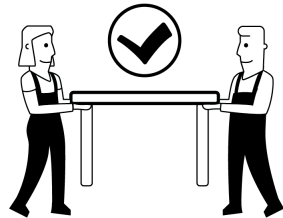
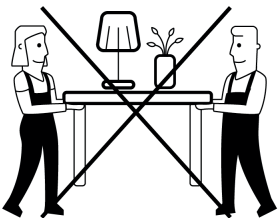
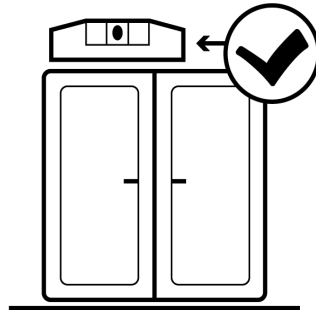
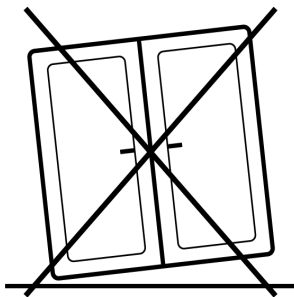
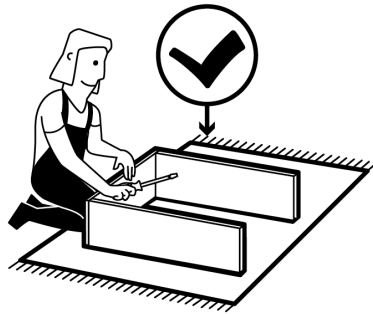
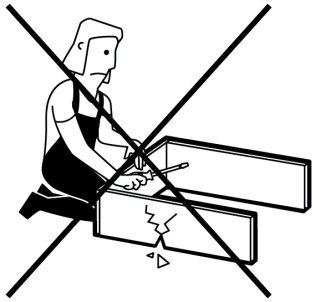

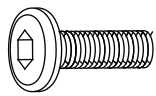
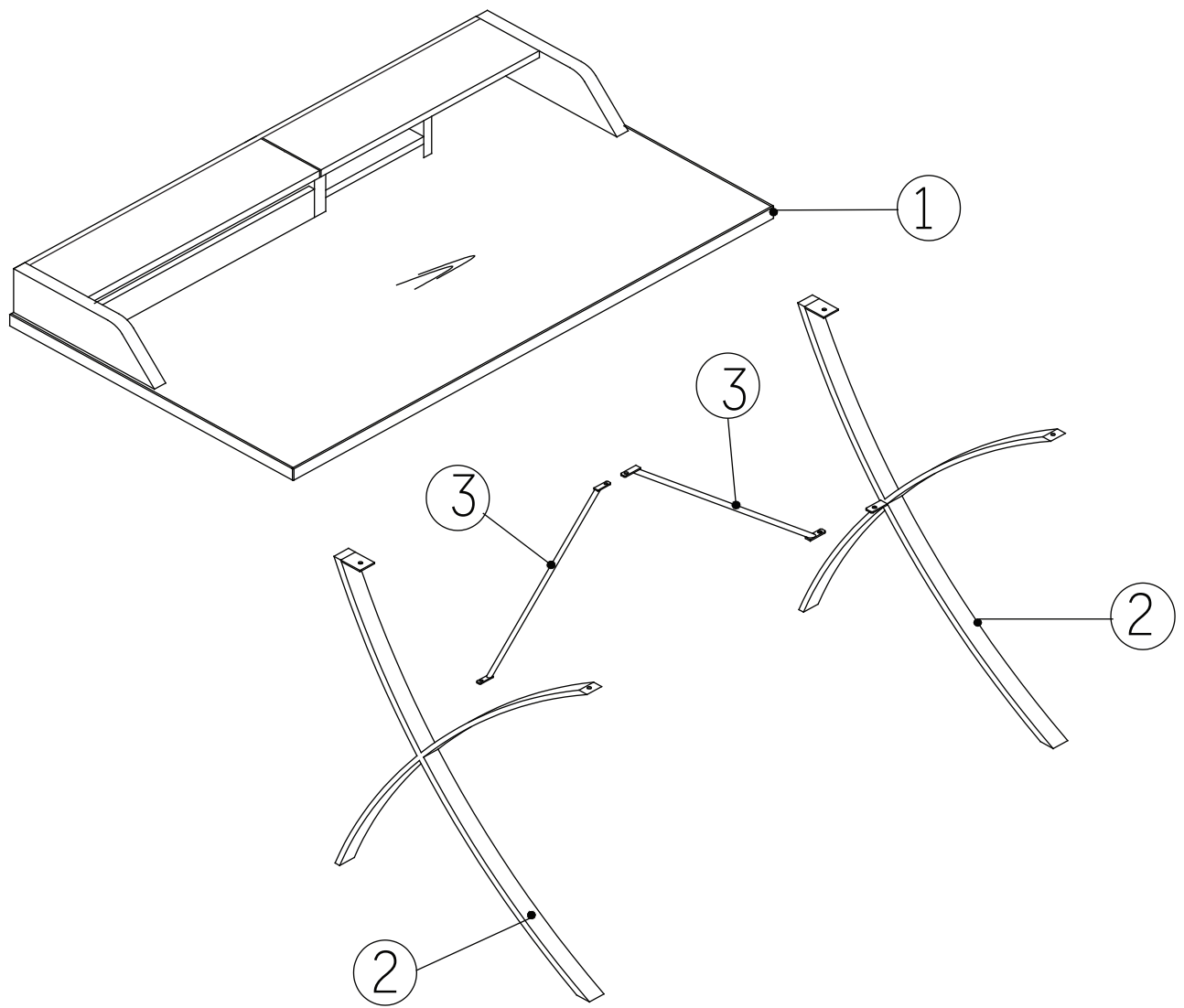

M6 x20MM

**A**

8X



Dia. 13MM

**B**

6X



Dia. 13MM

**C**

6X

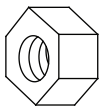

M6

**D**

2X

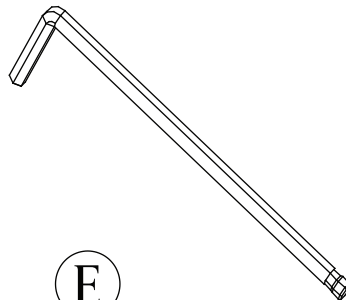

**E**

1X

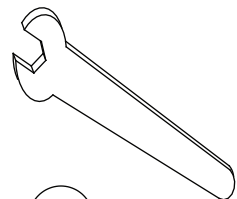

**F**

1X

1

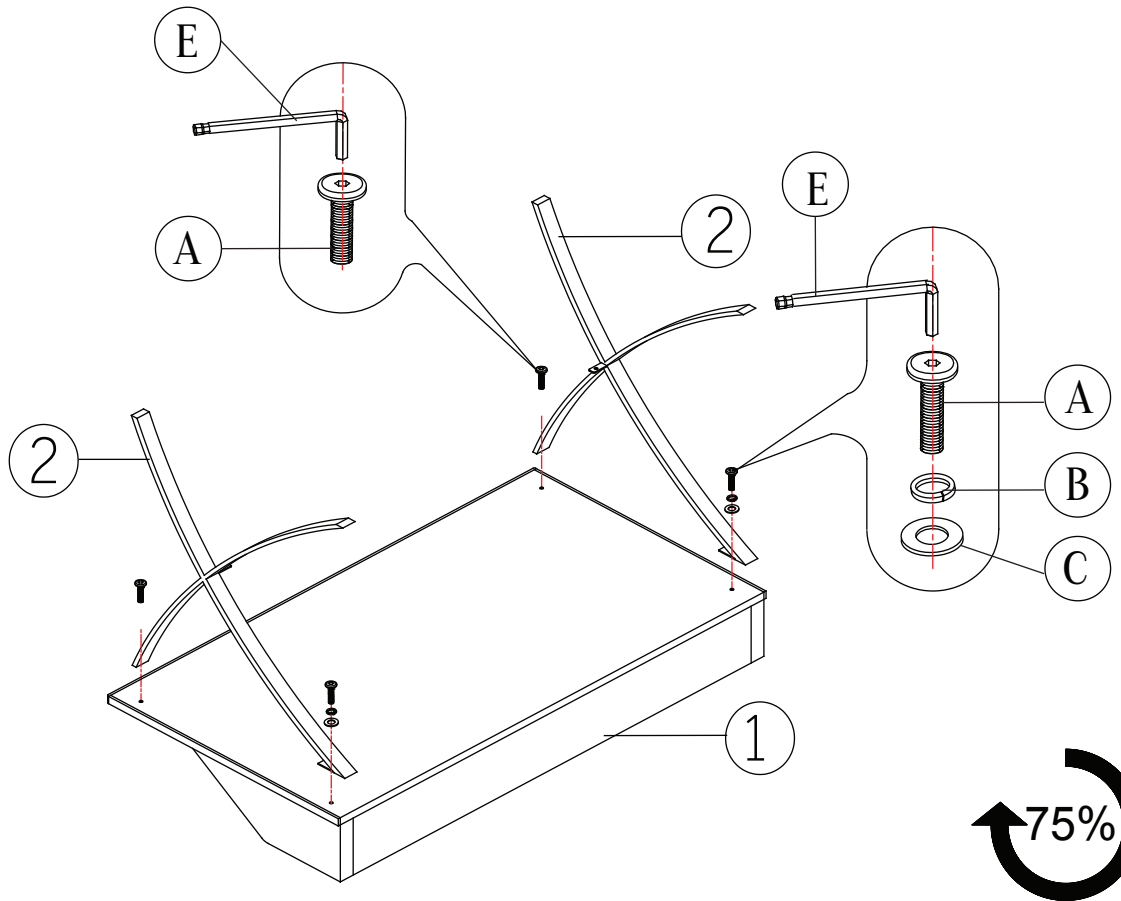

2

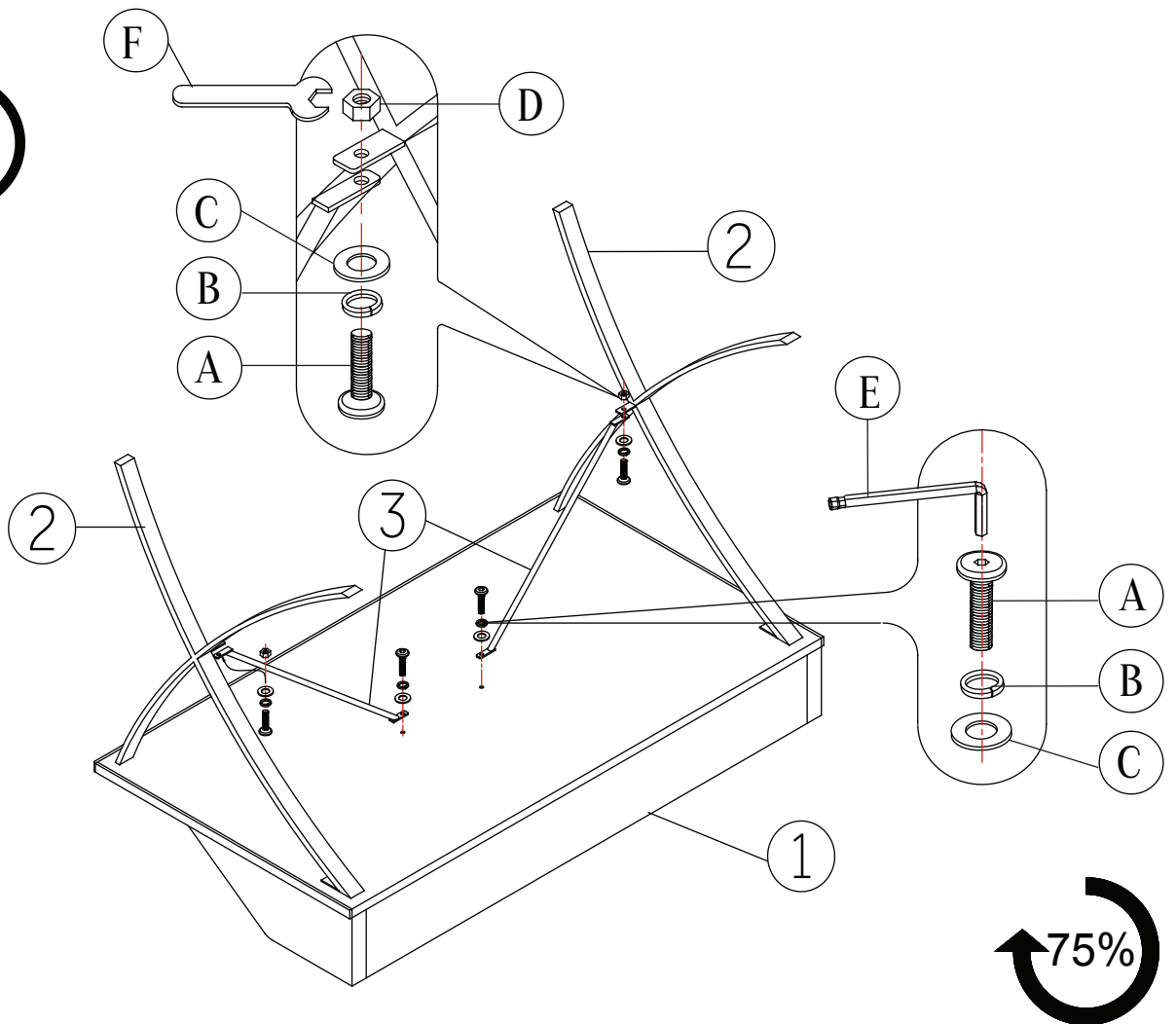

3

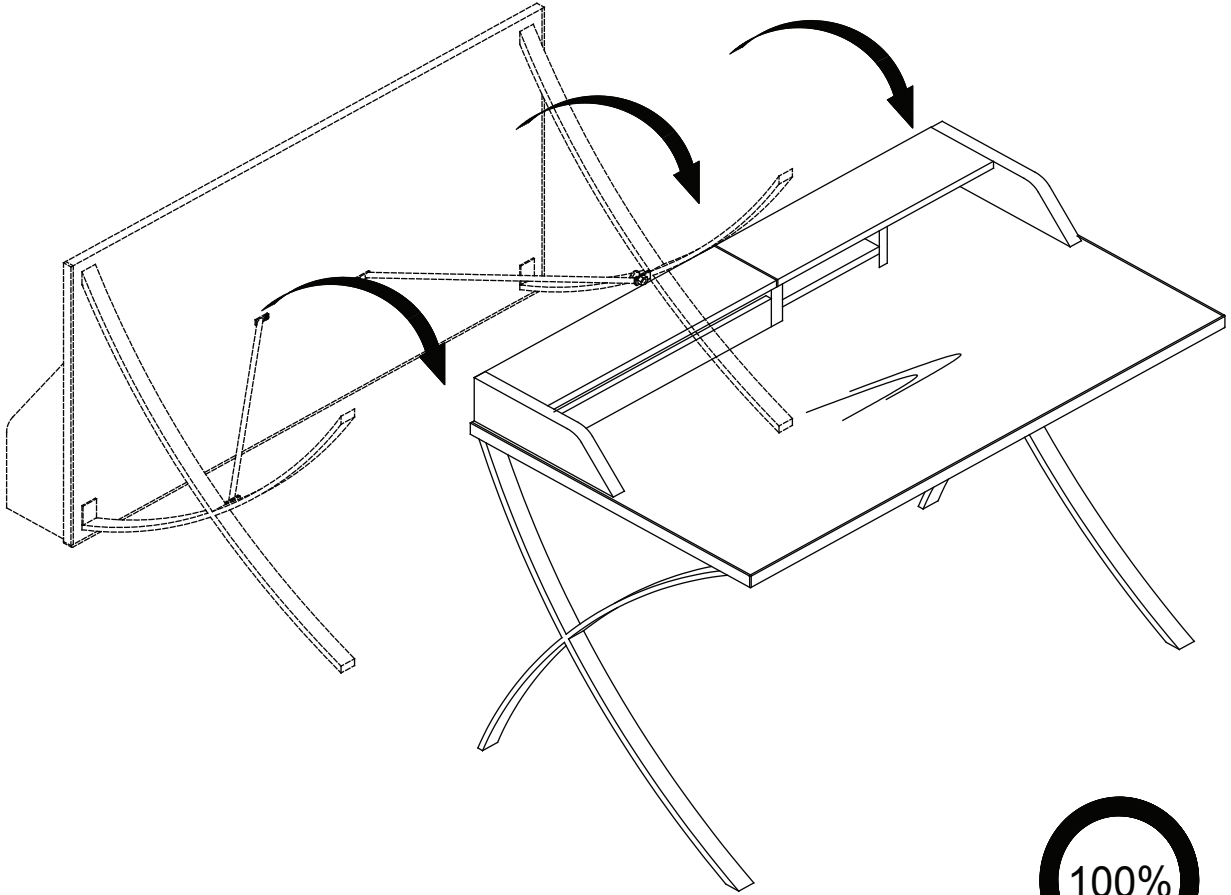

100%