

FACILE - EASY  
LEICHT - FÁCIL



2



FR / Si vous avez des questions sur votre produit, email: [laredoute@services.laredoute.fr](mailto:laredoute@services.laredoute.fr) ou appeler au: 0 969 323 515.

UK / If you need information about your product, email [helpline@redoute.co.uk](mailto:helpline@redoute.co.uk) or call: 033 0303 0199.

CH / Wenn Sie Fragen zu Ihrem Produkt, email: [info@redoute.ch](mailto:info@redoute.ch) oder anrufen: FR/IT: 0848 848 505, DE: 0848 848 505.

BE / Si vous avez des questions sur votre produit, email: [serviceclient@redoute.be](mailto:serviceclient@redoute.be) ou appeler: 056 85 15 15 - Als u vragen over uw product, email: [klantendienst@redoute.be](mailto:klantendienst@redoute.be) of bel: 056 85 15 00.

ES / Si tiene alguna pregunta acerca de su producto, email: [contacto@laredoute.es](mailto:contacto@laredoute.es) o llamar: 902 33 00 33.

PT / Se você tiver dúvidas sobre o seu produto, email: [contacto@redoute.pt](mailto:contacto@redoute.pt) ou chamar: 707201010.

SE / Om du har frågor om din produkt, email: [service@laredoute.se](mailto:service@laredoute.se) eller ring: 033 - 48 20 00.

NW / Hvis du trenger informasjon om produktet, email: [service@laredoute.no](mailto:service@laredoute.no) eller telefon: 66-89-15-00.

IT / Se hai delle domande sul tuo articolo, ecco la mail via nuestro website.

PL / Jeśli mają Państwo pytania dotyczące produktu, prosimy pisać na numer telefonu: 32 225 28 28.

RU / Если Вам необходима дополнительная информация о товаре, свяжитесь с нами по телефонам 8 800 555 75 35 / 8 (495) 795 30 30, email: [info@laredoute.ru](mailto:info@laredoute.ru).

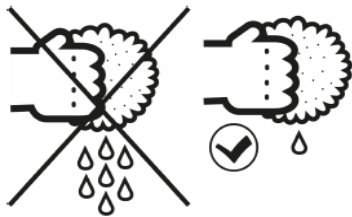
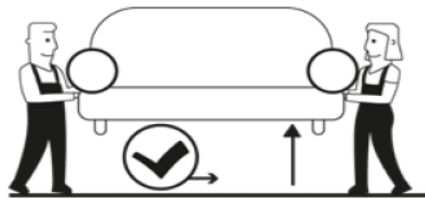
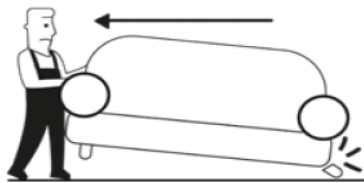
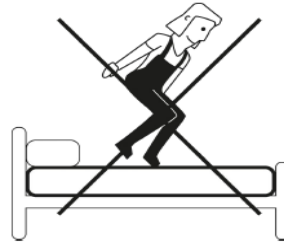
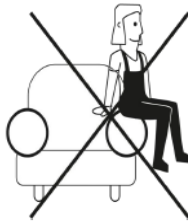
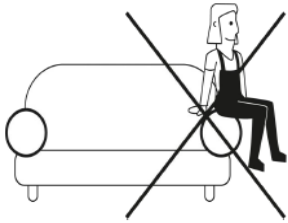
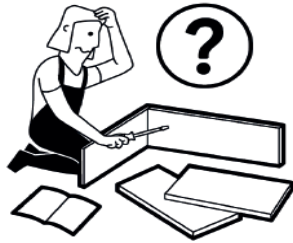
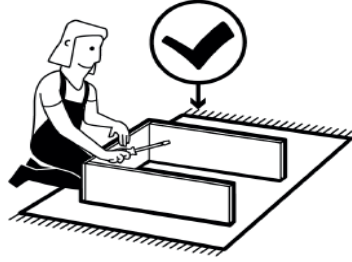
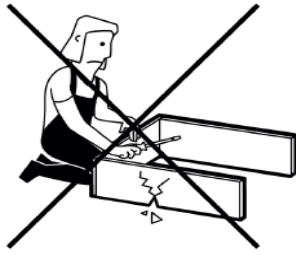

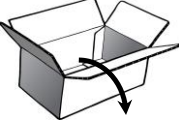

Pieds **A** x4

Rondelles **B** x4









15min



x2



  

 

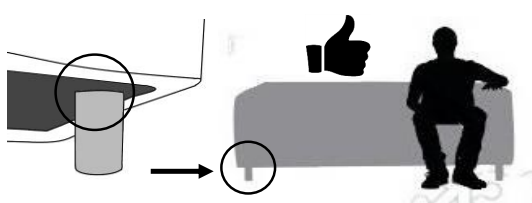
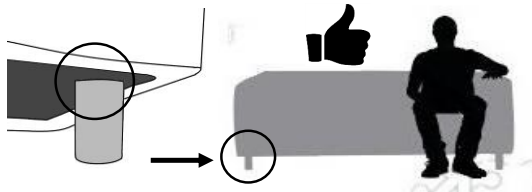

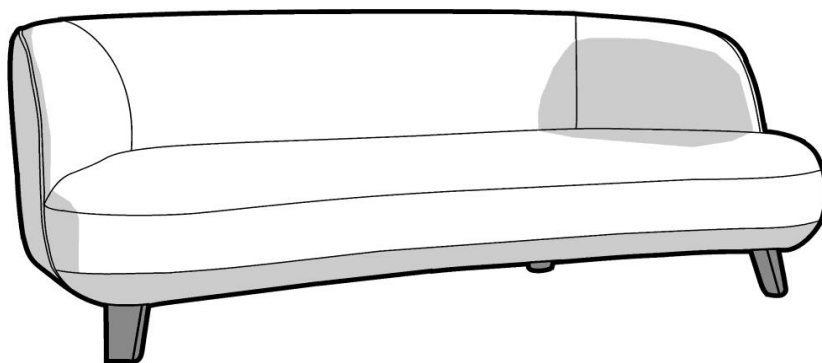
1.

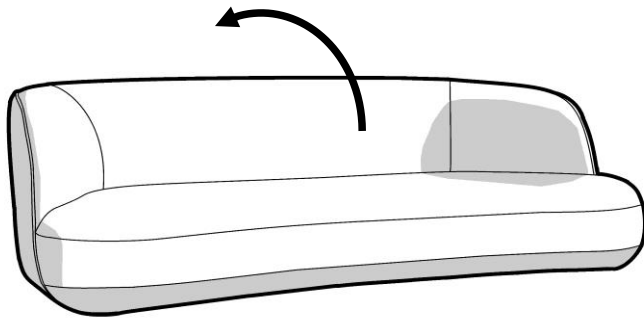

2.

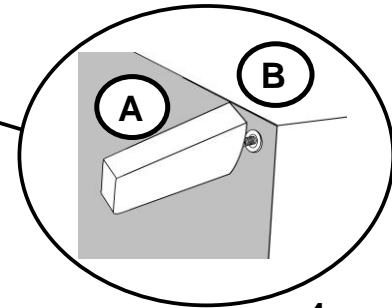
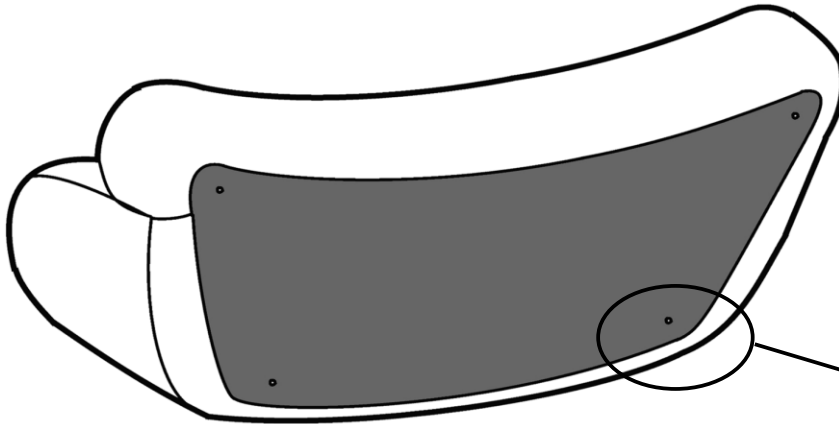

x4

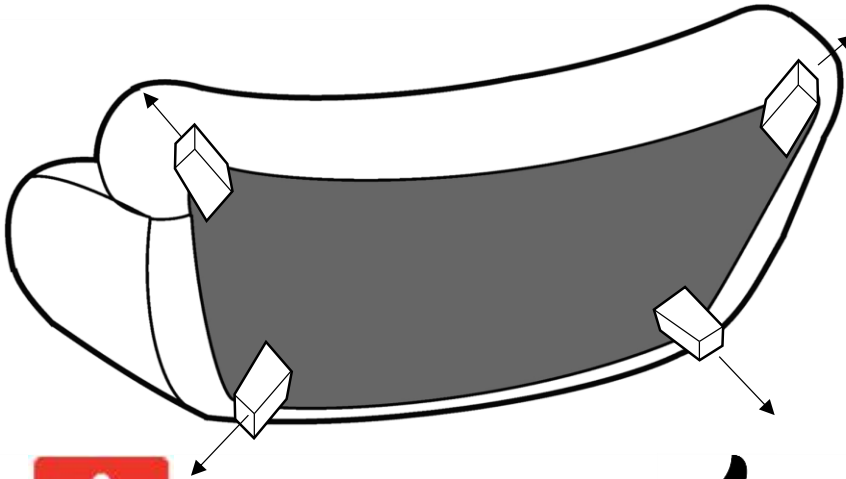

3.

